

MACSTROC®

QUALITY DEFINED



**LEADING THE WAY
WITH INNOVATIVE TOOLS !**



**EMPOWER YOUR TASKS
WITH OUR CUTTING-EDGE SOLUTIONS.**

MACSTROC®



PRODUCTS	PAGES
PIPE TOOLS	4-30
ELECTRIC PIPE THREADING MACHINES	4-7
MANUAL RATCHET THREADER /OILER/ CUTTING OIL	8
DIE HEADS/ NIPPLE CHUCK/ CUTTERS / REAMERS	9
DIES FOR PIPE THREADING MACHINES NPT & BSPT	10
ROLL GROOVER	11-16
ELECTRO-HYDRALIC / MANUAL PIPE CUTTERS	17-18
HOLE CUTTING MACHINE	19
PIPE STANDS , VISES, WORK BENCH, PIPE WELDING ALIGNMENT CLAMP	20-23
PRESSURE TEST PUMP	22
PIPE WRENCH, STRAP WRENCH, CHAIN WRENCH, AND CHAIN TONG	24-25
DRAIN CLEANING EQUIPMENT	26-30
METAL WORKING TOOLS	31-52
PIPE BEVELLING MACHINES, ELECTRIC AND PNEUMATIC	31
CUT-OFF SAW MACHINE 16"	32
PERMANENT LIFTING MAGNETS	33
MAGNETIC DRILLING MACHINES	34-38
ANNULAR CUTTERS - HSS, TCT, COBALT	39-46
RAIL ANNULAR CUTTER	46
SHEET METAL MINI-CUTTER , STEP DRILLS, COUNTERSINK	47
ACCESSORIES FOR MAGNETIC DRILLS	48
TCT HOLES AW FOR STAINLESS STEEL	49
TUNGSTEN CARBIDE BURRS	50-51
SEAM LOCKER, LASER DISTANCE METER, GLASS & TILE BITS	52
MACSTROC WARRANTY	53

PIPE TOOLS / THREADING

PORTABLE THREADING MACHINE

MEPT-3X



MODEL MEPT-3X THREADING MACHINE

The MEPT-3X, complete with its 'Support Arm' and a durable carrying case, is the ideal portable power drive for maintenance and repair work. It's also an excellent choice for service plumbers who need reliable pipe threading capabilities for pipes of up to 2 inches in diameter.



CAPACITY

Pipe: 1/4" - 2" [6MM-50MM]

Dieheads : 1/2", 3/4", 1", 1 1/4", 1 1/2", 2"

SPECIFICATIONS:

Motor: MEPT-3X is 1700W input, 1020W output, Universal motor 110V or 220V, 50/60Hz.

The switch features a heavy-duty paddle-type design and incorporates a safety lock-off device that automatically engages to secure the switch when released, ensuring enhanced safety in professional applications.

Incorporating a distinct mechanical transmission FOR/REV switch and boasting a reverse speed three times faster than threading, this system is equipped with a gear head featuring a robust spur gear reduction/ring gear drive, all shafts meticulously ball and needle bearing mounted, and a permanently lubricated gear housing, showcasing professional-grade functionality and performance.

The gear housing is constructed from die-cast aluminum, while the body and handle are made from durable, heavy-duty fiberglass-reinforced plastic, ensuring high-quality materials for professional use.

Spindle Speed: 28 RPM for threading, 51 RPM reverse (No load)

Die Heads: 1/2", 3/4", 1", 1 1/4", 1 1/2", 2" (Type *11R)

Includes support arm.

Screw Threads: NPT / BSPT

Dies Material: Alloy standard, (HSS optional)

Die Head Adapter: Used with 1/2" through 1 1/4" die heads.

weight: 8 kg (power drive) , 22Kgs complete set

Length: 76 cm



CODE	DESCRIPTION
MEPT-3X	1/2"-2" BSPT with 'Case and Support Arm' -110V OR 220V-1750W
MEPT-3XN	Machine - NPT
MEPT-YK2	Support arm for MEPT model
MOLR18	Oiler (optional*)
MTL401	1/4"-6" Portable tri-leg chain vise (optional*)

DIES RH			DIE HEAD
CODE	CODE	SIZE	CODE
BSPT DIES	NPT DIES		DIEHEAD
MBHS12	MNHS12	1/2"	MEPT12
MBHS34	MNHS34	3/4"	MEPT34
MBHS01	MNHS01	1"	MEPT01
MBHS114	MNHS114	1-1/4"	MEPT114
MBHS112	MNHS112	1-1/2"	MEPT112
MBHS02	MNHS02	2"	MEPT02

COMPACT THREADING MACHINE FLARE.2C



CAPACITY

Pipe: 1/4" -2"[6MM-50MM]

Bolt: 12MM-50MM

SPECIFICATIONS:

Motor: 1500W universal, 50/60Hz

Switch: Heavy-duty rotary Forward/off/reverse and integral foot switch.

Spindle Speed: 38 RPM.

Front Chuck: Hammer type with replaceable rocker action jaw inserts.

Rear Centering Device: Cam action.

Oiling System: Through the die head, with integral oil reservoir.

Pump: Self-priming constant flow, gerotor pump.

STANDARD SUPPLY

Model FLARE.2C Threading Machine. (110 or 220V)

Self-opening die head-SDH15A (BSPT or NPT)

1/2"-3/4" universal HSS dies set. (BSPT or NPT)

1"-2" universal HSS dies set. (BSPT or NPT)

Cutter-MHC2029 : Capacity: 1/8"-2"(3mm-50mm)

pipe Reamer-MHR1006 : Positive-locking, 5-flute cone, righthand 1/8"-2"(3mm-50mm).

*1 Gallon 'Power Fluid PF-9835' cutting oil.

Supplied with MFS642 foot switch,

MH6511 folding wheel stand (Optional)

*May not be supplied to certain countries

MODEL FLARE.2C THREADING MACHINE

Heavy-duty performance with 1500W motor. Portable/ Light-weight design.

Easy transport and set-up.

Self-Contained Oil System with adjustable flow control.

CODE	DESCRIPTION	RPM	PIPE	BOLT	KGs
FLARE.2C	WITH FOLDING TROLLEY WHEEL STAND 110V OR 220V 50/60 (NPT OR BSPT)	38	1/4-2" (6-50MM)	12-50MM	77
FLARE.2C-1	WITH PIPE LEGS 110V OR 220V 50/60 (NPT OR BSPT)	38	1/4-2" (6-50MM)	12-50MM	72

COMPACT THREADING MACHINE FLARE.3C



CAPACITY

Pipe: 1/4" -3" [6MM-75MM]

Bolt: 12MM-50MM

SPECIFICATIONS:

Motor: 1500W universal, 50/60Hz

Switch: Heavy-duty rotary Forward/off/reverse and integral foot switch.

Spindle Speed: 32 RPM.

Front Chuck: Hammer type with replaceable rocker action jaw inserts.

Rear Centering Device: Cam action.

Oiling System: Through the die head, with integral oil reservoir.

Pump: Self-priming constant flow, gerotor pump.

STANDARD SUPPLY

Model FLARE.3C Threading Machine. (110 or 220V)

Self-opening die head-SDH15A 1/2-2"(BSPT or NPT)

Self-opening die head-SDH28 2-1/2-3"(BSPT or NPT)
1/2"-3/4" universal HSS dies set. (BSPT or NPT)

1"-2" universal HSS dies set. (BSPT or NPT)

2-1/2"-3" universal HSS dies set. (BSPT or NPT)

Cutter-MHC2030 : Capacity: 1/4"-3"(6mm-80mm) pipe

Reamer-MHR1008 : Positive-locking, 5-flute cone, righthand 1/4"-3"(6mm-80mm).

*1 Gallon 'Power Fluid PF-9835' cutting oil.

Supplied with MFS642 foot switch, MH6511 folding wheel

*May not be supplied to certain countries

MODEL FLARE.3C THREADING MACHINE

Heavy-duty performance with 1500W motor. Portable/ Light-weight design.

Easy transport and set-up.

Self-Contained Oil System with adjustable flow control.

CODE	DESCRIPTION	RPM	PIPE	BOLT	KGs
FLARE.3C	WITH FOLDING TROLLEY WHEEL STAND 110V OR 220V 50/60 (NPT OR BSPT)	32	1/4-3" (6-75MM)	12-50MM	85
FLARE.3C-1	WITH PIPE LEGS 110V OR 220V 50/60 (NPT OR BSPT)	32	1/4-3" (6-75MM)	12-50MM	77

PIPE THREADING MACHINE FLARE.4C



CAPACITY

Pipe: 1/4" -4" [6MM-100MM]

Bolt: 12MM-50MM

SPECIFICATIONS:

Motor: 1500W induction, 50 OR 60Hz single phase

Switch: Heavy-duty rotary Forward/off/reverse and integral foot switch.

Spindle Speed: 36/20/11 RPM.

Front Chuck: Hammer type with replaceable rocker action jaw inserts.

Rear Centering Device: Cam action.

Oiling System: Through the die head, with integral oil

STANDARD SUPPLY

Model FLARE.4C Threading Machine. (110 or 220V)

Self-opening die head-SDHN71/SDHB91 (BSPT or NPT) 1/4-2"

Self-opening diehead-SDHN74/SDHB94 (BSPT or NPT) 2-1/2-4"

1/2"-3/4" universal HSS dies set. (BSPT or NPT)

1"-2" universal HSS dies set. (BSPT or NPT)

2-1/2"-4" HS Die set. (BSPT or NPT)

Cutter-MHC2032 : Capacity: 1/4"-4"(6mm-100mm) pipe
Reamer-MHR1010 : Positive-locking, 5-flute cone, righthand 1/4"-4"(6mm-100mm).

*1 Gallon 'Power Fluid PF-9835' cutting oil.

Supplied with MFS642 foot switch, MH1500 wheel stand (Optional)

*May not be supplied to certain countries

MODEL FLARE.4C THREADING MACHINE

Heavy-duty performance with 1500W induction motor; Threads 1/4"-3/4" at 36RPM,

1-2" at 20RPM, 2-1/2-4" at 11RPM

Easy transport with MH1500 stand

CODE	DESCRIPTION	RPM	PIPE	BOLT	KGs
FLARE.4C	WITH 'MH1500' WHEEL STAND 110V OR 220V 50 OR 60Hz (NPT OR BSPT)	36	1/4-4" (6-100MM)	12-50MM	150
FLARE.4C-1	WITH PIPE LEGS 110V OR 220V 50 OR 60Hz (NPT OR BSPT)	36	1/4-4" (6-100MM)	12-50MM	135

MANUAL RATCHET THREADER

CODE	DESCRIPTION	KGs
MBL-1250R	BSPT 1/2-2" COMPLETE SET 1/2, 3/4, 1, 1-1/4, 1-1/2 and 2"	25
MNP-1250R	NPT 1/2-2" COMPLETE SET 1/2, 3/4, 1, 1-1/4, 1-1/2 and 2"	25
1250-RTH	Handle for ratchet threader	5



RATCHET THREADER - DIE HEAD*

CODE BSPT	CODE NPT	SIZE
MBHS12-D	MNHS12-D	1/2"
MBHS34-D	MNHS34-D	3/4"
MBHS01-D	MNHS01-D	1"
MBHS114-D	MNHS114-D	1-1/4"
MBHS112-D	MNHS112-D	1-1/2"
MBHS02-D	MNHS02-D	2"

RATCHET THREADER - RH DIES*

CODE BSPT	CODE NPT	SIZE
MBHS12	MNHS12	1/2"
MBHS34	MNHS34	3/4"
MBHS01	MNHS01	1"
MBHS114	MNHS114	1-1/4"
MBHS112	MNHS112	1-1/2"
MBHS02	MNHS02	2"

*OPTIONALLY BE USED IN RIDGID

CODE	DESCRIPTION
MOLR18	OILER



CODE	DESCRIPTION
PF-9835	Thread cutting Oil NON-SOLUBLE 1Gal (3.785Ltrs)
PF-9835-2	Thread cutting Oil NON-SOLUBLE - 20Ltrs
SF-4849	WATER SOLUBLE, 1Gal multi-purpose cutting oil
SF-4849-2	WATER SOLUBLE 20Ltrs multipurpose cutting oil
VAC-L01	Vacuum Pump Oil, 1Ltr

LUBRICANTS



DIE HEADS



MODEL SDH15A



MODEL QDH11A



MODEL SDHN71/B91



MODEL SDHN74/B94

DIE HEADS *OPTIONALLY BE USED IN RIDGID

CODE	SIZE	THREAD	DESCRIPTION
SDHN15A	1/8"-2"	NPT	Self opening
SDHB15A	1/8"-2"	BSPT	Self opening
QDHN11A	1/8"-2"	NPT	Quick opening
QDHB11A	1/8"-2"	BSPT	Quick opening
SDHN28	2-1/2"-3"	NPT	Self opening
SDHB28	2-1/2"-3"	BSPT	Self opening
SDHN71	1/4"-2"	NPT	Univ Self opening
SDHB91	1/4"-2"	BSPT	Univ Self opening
SDHN74	2-1/2"-4"	NPT	Self opening
SDHB94	2-1/2"-4"	BSPT	Self opening



NIPPLE CHUCK

CODE	SIZE	THREAD
MNC11-N	1/2"-2"	NPT
MNC11-B	1/2"-2"	BSPT



PIPE CUTTER FOR THREADING MACHINES

CODE	SIZE	MACHINE
MHC2029	1/4"-2"	FLARE.2C
MHC2030	1/4"-3"	FLARE.3C
MHC2032	1/4"-4"	FLARE.4C



REAMER FOR THREADING MACHINES

CODE	SIZE	MACHINE
MHR1006	1/4"-2"	FLARE.2C
MHR1008	1/4"-3"	FLARE.3C
MHR1010	1/4"-4"	FLARE.4C

PIPE TOOLS / THREADING DIES

PREMIUM QUALITY PIPE THREADING DIES

NPT -RH DIES *OPTIONALLY BE USED IN RIDGID

CODE ALLOY-RH	CODE HSS-RH	SIZE	THREAD
NAL-0	NHS-0	1/4"-3/8"	NPT
NAL-1	NHS-1	1/2"-3/4"	NPT
NAL-2	NHS-2	1"-2"	NPT
NAL-3	NHS-3	2-1/2"-3"	NPT
NAL-4	NHS-4	2-1/2"-4"	NPT



*100% SATISFACTION MONEY BACK
GURANTEE ON HIGH-SPEED 'HSS' DIES

*REVIEW GURANTEE TERMS WITH LOCAL
DISTRIBUTOR

*OPTIONALLY BE USED IN RIDGID,
ROTHENBERGER, REX, AND ASADA
THREADING MACHINES

BSPT -RH DIES *OPTIONALLY BE USED IN RIDGID

CODE ALLOY-RH	CODE HSS-RH	SIZE	THREAD
BAL-0	BHS-0	1/4"-3/8"	BSPT
BAL-1	BHS-1	1/2"-3/4"	BSPT
BAL-2	BHS-2	1"-2"	BSPT
BAL-3	BHS-3	2-1/2"-3"	BSPT
BAL-4	BHS-4	2-1/2"-4"	BSPT



HS-RH DIES *OPTIONALLY BE USED IN REX AND ASADA

CODE FOR *ASADA -HS (RH)	CODE FOR *REX-HS (RH)	SIZE	THREAD
ANHS-1	RNHS-1	1/2"-3/4"	NPT
ANHS-2	RNHS-2	1"-2"	NPT
ABHS-1	RBHS-1	1/2"-3/4"	BSPT
ABHS-2	RBHS-2	1"-2"	BSPT

PORTABLE GROOVING MACHINE, COLT-6

The COLT-6 Roll Groover model stands out as the most durable and efficient lightweight (17kgs) portable grooving unit, making transportation easy. It boasts a robust cast-iron housing designed for heavy-duty usage. What sets the COLT-6 apart is its single stroke-feed mechanism, enabling precise and effortless operation. Additionally, the COLT-6 can be mounted on Macstroc's "Flare.2C and 3C" or optionally used with *Ridgid machine.



Capacity:

1¼"-6" Sch. 10 steel, stainless steel.

1¼"-3" Sch. 40 steel, stainless steel.

Standard dies: One 1¼"-6" Roll Groove Set.

(1¼"-6" Sch. 10, 1¼"-3" Sch. 40)

CODE	DESCRIPTION
COLT-6	ROLL GROOVER
KR6-1146	ROLL SET 1¼"-6"
MBH107	PIPE SUPPORT STAND(OPTIONAL)

PORTABLE GROOVING MACHINE, COLT-12

The Model COLT-12 Hydraulic Roll Groover Built with powerful 15-ton hydraulic ram, compact and easy to transport. One man set-up and operation, the COLT-12 is the ideal groover for work site. Designed to provide maximum efficiency, the COLT-12 is capable of grooving up to 12" Schedule 10 and 8" Schedule 40 standard wall pipes. Roll set changeout is accomplished in seconds.

The COLT-12 mounts quickly to Macstroc FLARE.4C machine.

Or optionally can be used in *Ridgid machines.



Technical Specifications

Capacity: 2"-12" Sch. 10 steel, stainless steel

2-8 Sch. 40 steel, stainless steel

Weight: 53 kg

Standard dies:

One 2"-6" Schedule 10/40 Roll Set

One 8-12° Schedule 10 (8° Schedule 40) Roll Set

CODE	DESCRIPTION
COLT-12	ROLL GROOVER WITH MOUNTING BASE FOR FLARE.4C
KR12-0206	ROLL SET 2"-6"
KR12-0812	ROLL SET 8"-12"
KR-MF4	MOUNTING BASE FOR FLARE.4C



PIPE TOOLS / GROOVING

VERSATILE ROLL GROOVER, COLT-12GX



CAPACITY:

1"-8" SCH10/40 STEEL

1-6" SCH10/40 STAINLESS STEEL

10"-12" Sch. 10/20 STEEL

8" -12" SCH10/20 STAINLESS STEEL

MAX WALL THICKNESS : 8MM

NET WEIGHT : 18KGS

Model COLT-12GX Roll Groovers are designed to groove manually or can be mounted on a threading machine. It is a highly versatile portable roll grooving machine suitable for medium-volume grooving both on the job site and for in-place pipe grooving. Users have the flexibility to utilize it either with the Macstroc Flare.2C threading machine, utilizing a chuck attachment, or, as an alternative, with a *Ridgid Threading machine. Additionally, it is well-suited for on-site manual roll grooving operations, operating autonomously without the need for an external power supply.

COLT-12GX is a heavy-duty design for fire-fighting and industrial pipelines in the size range of 1" to 12" (DN25 to DN300), SCH10 to SCH40. The presence of a groove depth lock nut guarantees the production of consistently high-quality grooves, resulting in enhanced grooving efficiency. Additionally, the machine facilitates rapid and effortless shaft swapping, with a process completion time of just 30 seconds.

STANDARD EQUIPMENT

CODE	DESCRIPTION
COLT-12GX	COMBO ROLL GROOVER 12GX
DR11010	DRIVE ROLLER 1-1/4" — 1-1/2"
DR11009	DRIVE ROLLER 2" — 6"
DR11008	DRIVE ROLLER 8" — 12"
GR12016	GROOVE ROLLER 1" — 6"
GR12005	GROOVE ROLLER 8" — 12"
RS98036	SOCKET AND RATCHET WRENCH

OPTIONAL ACCESSORIES

CODE	DESCRIPTION
DR11011	DRIVE ROLLER 1"
SA11016	SUPPORT ARMS (X2) FOR FLARE.2C / *RIDGID 300
DA11015	DRIVE BAR ADAPTER
BSH98114	BRACKET SET FOR THREADING MACHINE*



ROLL GROOVING TOOL, MRG-8V1



MRG-8V1 Roll-Groover Powered by 800W induction motor, hydraulic pump and convenient depth adjusting function, it is designed to form roll groove on standard wall pipes 1"-8" SCH10 to SCH40. Convenient drive shaft design for easy replacement. A high-performance gear reduction motor contributes to compact size and low noise. The machine comes with a foldable stand and the unit can be easily moved. Induction motor ensures stable and quiet operation.

SPECIFICATIONS

- Power groover 1"-8" [Sch10/40] Steel
- 1"-6" [Sch10/40] SS
- Motor: 800w induction
- Speed: 23 RPM
- Standard roll set: 1-1-1/2" ; 2-6" ; 8"
- Max Wall thickness: 8mm
- Net weight: 63kg

STANDARD EQUIPMENT

- Model MRG-8V1 grooving machine.
- 1—1-1/2" Schedule 10/40 Roll Set.
- 2—6" Schedule 10/40 Roll Set
- 8" Schedule 10/40 Roll Set
- MH98078** Pipe Support Stand & **MFS-641** Foot switch.



CODE	DESCRIPTION
GRM-8V1	Electro-Hydraulic Roll Grooving tool 800W 110V OR 220V 50/60HZ NW.63KGS
DR11042	Drive Roller 1—1-1/2"
DR11043	Drive Roller 2—6"
DR11044	Drive Roller 8"
GR12011	Groove Roller 1—1-1/2"
GR12012	Groove Roller 2—6"
GR12013	Groove Roller 8"
MH98078	Pipe support stand
PS98033	Pipe Stabilizer * Optional
GMT-100	Groove measure tape

ROLL GROOVING TOOL, MRG-12V1



STANDARD EQUIPMENT

- Model MRG-12V1 grooving machine.
- [1—1-1/2"] Schedule 10/40 Roll set
- [2—3"] Schedule 10/40 Roll set
- [3-1/2—6"] Schedule 10/40 Roll set
- [8—12"] Schedule 10 Roll set

***MH98082** Pipe Support Stand & **MFS-641** Foot switch.

MRG-12V1, The light weight Roll-Grover Powered by 1100W induction motor, hydraulic pump and convenient depth adjusting function, it is designed to form roll groove on standard wall pipes 1-8" SCH10/SCH40 and 10-12" SCH10. A high-performance gear reduction motor contributes to compact size and low noise. Induction motor ensures stable and quiet operation. A light weight of 65 kg makes the machine easy to move.

SPECIFICATIONS

Power groover 1"-12" [SCH10/40] Steel

1-8"[SCH10/40] 10-12"[SCH10] SS

Motor: 1100w induction

Speed: 23 RPM

Standard roll set: [1—1-1/2"] [2—3"] [3-1/2—6"] [8—12"]

Max Wall thickness: 8mm

Net weight: 65kg



CODE	DESCRIPTION
MRG-12V1	Electro-Hydraulic Roll Grooving tool 1100W 110V OR 220V 50 /60HZ NW.65KGS
DR11106	Drive Roller 1—1-1/2"
DR11107	Drive Roller 2—3"
DR11108	Drive Roller 3-1/2—6"
DR11109	Drive Roller 8—12"
GR12041	Groove Roller 1—1-1/2"
GR12042	Groove Roller 2—6"
GR12043	Groove Roller 8-12"
MH98082	Pipe support stand
PS98011	Pipe Stabilizer * Optional
GMT-100	Groove measure tape

ROLL GROOVING TOOL, MRG-12V2



STANDARD EQUIPMENT

Model MRG-12V2 grooving machine.

[2—3"] Schedule 10/40 Roll set

[3-1/2—6"] Schedule 10/40 Roll set

[8—12"] Schedule 10/40 Roll set

***MH98082** Pipe Support Stand & **MFS-641** Foot switch.

MRG-12V2, Heavy-duty Roll-Grover Powered by 1100W induction motor, hydraulic pump and convenient depth adjusting function, it is designed to form roll groove on standard wall pipes 2"-12" SCH10/SCH40. Convenient drive shaft design for easy replacement. A high-performance gear reduction motor contributes to compact size and low noise. Induction motor ensures stable and quiet operation. Capable of making groove in 10MM wall thickness pipes.

SPECIFICATIONS

Power groover, Heavy-Duty 2"-12" [SCH10/40] Steel

2-12"[SCH10/40] SS

Motor: 1100w induction

Speed: 23 RPM

Standard roll set: [2—3"] [3-1/2—6"] [8—12"]

Max Wall thickness: 10mm

Net weight: 110kg



PIPE SUPPORT STAND, MH98082



CODE	DESCRIPTION
MRG-12V2	Electro-Hydraulic Roll Grooving tool 1100W 110V OR 220V 50 /60HZ NW.110KGS
DR11022	Drive Roller 2—3"
DR11021	Drive Roller 3-1/2—6"
DR11020	Drive Roller 8—12"
GR12010	Groove Roller 2—3"
GR12009	Groove Roller 3-1/2—6"
GR12008	Groove Roller 8—12"
MH98082	Pipe support stand
PS98011	Pipe Stabilizer * Optional
GMT-100	Groove measure tape *Optional

PIPE TOOLS / GROOVING

ROLL GROOVING TOOL, MRG-24IVA



MRG-24IVA, Heavy-duty Roll-Groover Powered by 2200W induction motor, hydraulic pump and convenient depth adjusting function, it is designed to form roll groove on standard wall pipes 8"-24" SCH10/SCH40. Convenient drive shaft design for easy replacement. A high-performance gear reduction motor contributes to compact size and low noise. Induction motor ensures stable and quiet operation. Capable of making groove in 13MM wall thickness pipes.

SPECIFICATIONS

- Power groover 8"-24" Steel /SS
- 8-16"[SCH10/40] 18-24"[SCH10/20]
- Motor: 2200w induction
- Speed: 20 RPM
- Standard roll set: [8—12"] [14—16"] [18—24"]
- Max Wall thickness: 13mm
- Net weight: 170kg

STANDARD EQUIPMENT

Model MRG-24IVA grooving machine.
 [8—12"] & [14—16"] Schedule 10/40 Roll set
 [18—24"] Schedule 10/20 Roll set
 ***MH98038** Pipe Support Stand & **MFS-641** Foot switch.



CODE	DESCRIPTION
MRG-24IVA	Electro-Hydraulic Roll Grooving tool 2200W 380-415V 3Phase 50 /60HZ NW.170KGS
DR11087	Drive Roller 8—12"
DR11088	Drive Roller 14—16"
DR11089	Drive Roller 18—24"
GR12029	Groove Roller 8—12"
GR12030	Groove Roller 14—16"
GR12031	Groove Roller 18—24"
MH98038	Pipe support stand
PS98011	Pipe Stabilizer

PIPE CUTTING MACHINE, TERCEL.8 | TERCEL.12

The "Tercel.8" is an electro-hydraulic pipe cutter designed for cutting 2"-8" schedule 10/40 steel pipes or galvanized pipes. The "Tercel.12" is a heavy-duty electro-hydraulic pipe cutter suited for cutting 2"-12" schedule 10/40 steel pipes or galvanized pipes. Both models feature a hydraulic hand pump that allows for easy feeding, resulting in clean cuts with no sparks, abrasive dust, or open flames. The processed pipes can be further threaded or grooved, and the inclusion of a robust induction motor guarantees a noise-free operation.



CODE	SPECIFICATIONS	NW-KG
TERCEL.8	CODE: TERCEL.8 Cutting Capacity: 2" to 8" schedule 10/40 Motor: 550W induction, 220V 50/60Hz Spindle Speed: 24 RPM Switch: ON/OFF heavy duty switch Supplied with Ball Bearing Pipe Support *CODE: MH1032	65
TERCEL.12	Cutting Capacity: 2" to 12" schedule 10/40 Motor: 750W induction, 50/60Hz Spindle Speed: 24 RPM Switch: ON/OFF heavy duty switch Supplied with Ball Bearing Pipe Support *CODE: MH2011	120
TERCEL.8-12/P-128B	Cutting Blade for Tercel.8 and Tercel.12	1.23

HINGED PIPE CUTTERS

The cutters operate with minimal cutter rotation (90-110 degree) as necessary for tight quarters, with four blades which Designed for rapid cutting of 1” through 8” steel, heavy-wall steel and cast-iron pipes. There is no sparks during cutting operation, serving jobs with such special requirements.



CODE PIPE CUTTER	Ø PIPE DIA	WALL THICKNESS STEEL (MM)	WALL THICKNESS CAST-IRON (MM)	WALL THICKNESS SS (MM)	N.W KGS	CODE CUTTING WHEEL
MHP12	1-2 1/2” 25-63mm	2.77 - 6.02	3 - 6	3 - 6	3.3	MHP12/W4
MHP24	2-4” 50-100mm	2.77 - 6.02	3 - 6	3 - 6	6.5	MHP24/W4
MHP46	4-6” 100-150mm	3 - 7.11	3 - 6	3 - 6	9	MHP46/W4
MHP68	6-8” 150-200mm	3.4 - 8.18	3.4 - 6	3.4 - 6	12	MHP68/W4
MHP0812	8-12”	3.4-8.2	NA	NA	25.8	MHP0812/W4

LOW CLEARANCE ROTARY CUTTER

With good leverage from the tool’s long handle, pipe snaps off squarely before the cutter wheels penetrate halfway through the pipe. Provides a square cut and can be used in close quarters.

anywhere; in the ditch, underwater, in noise-free zones, over head, in racks of pipes, etc... Operates with minimal cutter rotation (45 degree). Suitable to cut steel, cast iron, galvanized, ductile iron black iron and stainless steel pipes.



CODE PIPE CUTTER	Ø PIPE DIA	WALL THICKNESS STEEL (MM)	WALL THICKNESS CAST-IRON (MM)	WALL THICKNESS SS (MM)	N.W KGS	CODE CUTTING WHEEL
MHP0610	06-10”	3.4 - 9.27	10.97-15.06	3.4 - 9.27mm	20.8	MHP0610/W4
MHP1014	10-14”	4.19 - 11.1	4.19 - 6	4.19 - 6	23	MHP1014/W4
MHP1618	16-18”	6.35mm-14.3mm (Sch10/40)	6.35mm - 13mm	6.35mm - 13mm	31	MHP1618/W4
MHP2022	20-22”	6.3mm-15mm (Sch10/40)	6.35mm - 13mm	6.35mm - 13mm	42	MHP2022/W4

HOLE CUTTING MACHINE, FERRO.4A



The FERRO.4A is designed for drilling up to 4Inches (114MM) into steel pipes. Light-weight compact design, allows you for drilling in small diameters. 1500W universal motor ensures quiet working performance. Two way feed handle can operate the tool from either left or right .

Specification

CODE: FERRO.4A

Cutting Capacity: up to 4" (114mm)

Pipe Mounting Capacity: 1 1/4"-8" (31mm-219mm)

Drill Chuck Capacity: 3-16mm

Drill Chuck Speed: 240RPM (no load)

Motor: Universal, 1500W

Size: H-513mm ; L-260mm ; W-248mm

N weight: 16Kgs

HOLE CUTTING MACHINE, FERRO.6



Model FERRO.6 is designed for drilling holes up to 6"(152MM) into steel pipes. The 'Ferro.6' has a 5/8" (16mm) capacity drill chuck to use all sizes of hole saws and hole saw arbors. An integral motor and gear reduction optimizes performance of large diameter hole saws. Two way feed handle can operate the tool from either left or right .

Specification

CODE: FERRO.6

Cutting Capacity: up to 6" (152mm)

Pipe Mounting Capacity: 1 1/4"-12" (30mm-300mm)

Drill Chuck Capacity: 3-16mm

Drill Chuck Speed: 110RPM (no load)

Motor: Universal, 1500W

Size: H-303mm ; L-340mm ; W-315mm

N weight: 17Kgs

PIPE TOOLS / STANDS & VISE

PORTABLE TRI-LEG CHAIN VISE 6"

Folding legs for easy transport and setup; Holes and slots for bending; cutting or attaching tools; Light-weight and strong.



CODE	SIZE
MTL401	For pipes Ø 1/4"-6"

V HEAD PIPE STAND WITH BALL TRANSFER HEAD



Height Adjustment: 32" to 55"

Max Pipe Capacity: 12"

Max Weight Capacity: 2500lbs

CODE	DESCRIPTION
MBH107	Max. pipe capacity 12"
BTH-R	Ball Transfer Head

FOLDING WHEEL STAND FOR FLARE.2C/FLARE.3C



CODE	DESCRIPTION
*MH6511	For FLARE.2C/3C
*MH1500	For FLARE.4C

WHEEL STAND FOR FLARE.4C



*OPTIONALLY BE USED FOR RIDGID THREADING MACHINE

CODE	MH98082
------	---------

PIPE SUPPORT FOR GROOVER 12"



CODE	MH1200
------	--------

PIPE SUPPORT FOR GROOVER 12"



CODE	MH1202
------	--------

PIPE SUPPORT FOR GROOVER 12"



CODE	MH1032
------	--------

PIPE SUPPORT FOR TERCEL.8



CODE	MH2011
------	--------

PIPE SUPPORT FOR TERCEL.12



CODE	MH021	MH023	MH025
------	-------	-------	-------

BENCH YOKE VISE 2" | 3" | 4"



CODE	MH0109
------	--------

ROLLER HEAD STAND-12" PIPE

Height Adjustment: 32" to 55"

Max Pipe Capacity: 12"

Max Weight Capacity: 1000 lbs



CODE	MH0402
------	--------

PIPE VISE 1/8"-6"



CODE	MH038
------	-------

BENCH YOKE VISE 3-50MM



WORKBENCH FOLDABLE TYPE



CODE	MWB1075
------	---------

Sturdy, easy to carry folding workbenches for workshops resistant up to 300Kgs. Heavy duty tubular steel frame with an thick wooden worktop. Dimension : (L x W x H) 1075x625x825 MM.

*custom sizes can be made.

PIPE WELDING ALIGNMENT CLAMPS



CODE	DESCRIPTION
MUC125	Ultra Clamp 1"-2.1/2" (25-65mm) weight: 2.2Kgs
MUC026	Ultra Clamp 2" - 6" (50-150mm) weight: 3.8Kg
MUC512	Ultra Clamp 5"-12" (127-300mm) weight: 9 kg

PIPE ROLLER STAND

CODE	MPRS500
------	---------

Roller stand: For 75-500 mm pipes



ADJUSTABLE STAND WITH STEEL ROLLERS

CODE	MAS236
------	--------

Roller head pipe stand 2"-36"

For pipe supporting 2"-36"

Rollers can be adjustable

Max load weight: 1133 kg



BIG V-HEAD STAND 4-36"

CODE	MBHS36
------	--------



Supports 1135kg
 Maximum of 36" (900mm)
 Minimum of 4" (100mm pipes).
 Adjustable height : 28-52 inches
 Large Vee : 30CM
 *custom sizes can be made.

FABRICATOR STAND W/ ROLLER HEAD & CASTER

CODE	MFRC36
------	--------

4 legged stand for fix up, rotating and welding. hold 4"-36" pipes . Adjustable Height with 8" castor wheels. Capacity : 1135Kg

Operating Height with casters :
 32"(82cm)-39"(100cm)

Operating Height w/out casters:
 23"(59cm)-30"(77mm)

Weight:
 Frame: 9.2kg
 V head assembly: 10.4 kg
 Urethane caster:
 3.35 kg x 4
 Total : 33Kg





PRESSURE TEST PUMP

CODE	MHSY6012
------	----------

Testing range: 0-60 bar(860 psi,6 MPa)
 Tank capacity: 12 L
 Flow/stroke:≈45 ml
 Connection :1/2" BSPP
 Valve : brass
 Water tank : steel
 Metal handle with rubber sleeve





STRAIGHT PIPE WRENCHES

CODE	Ø SIZE	MM 	INCH 	KG
MPW06	06"	20	3/4	0.2
MPW08	08"	25	1	0.3
MPW10	10"	33	1 1/2	0.8
MPW12	12"	42	1-5/8	1.2
MPW14	14"	50	1-3/4	1.6
MPW18	18"	62	2 3/8	2.6
MPW24	24"	73	3	3.75
MPW36	36"	102	4	8.5
MPW48	48"	141	5.5	15
MPW60	60"	219	8	20



ALUMINUM STRAIGHT PIPE WRENCHES

CODE	Ø SIZE	MM 	INCH 	KG
MAPW10	10"	33	1 1/2	0.8
MAPW12	12"	42	1-5/8	1.2
MAPW14	14"	50	1-3/4	1.6
MAPW18	18"	62	2 3/8	2.6
MAPW24	24"	73	3	3.75
MAPW36	36"	102	4	8.5
MAPW48	48"	141	5.5	15



THUMBTURN PATTERN PIPE WRENCH

CODE	SIZE-IN	TOTAL LENGTH MM	JAW AJUSTMENT  MM	KG
MTP175	7"	210mm	45	1.06
MTP225	9"	260mm	55	1.11
MTP300	12"	370mm	75	1.15



STRAP WRENCH

CODE	⇒ Ø PIPE ⇐	LENGTH	STRAP L
MSW128	8"	12"	34"



CHAIN TONGS

CODE	Ø CAPACITY-IN	LENGTH	CHAIN LENGTH	KG
MCT142	1/4 - 2 1/2	690	419	3.8
MCT344	3/4 - 4	900	747	8.0
MCT016	1 - 6	1000	897	10.0
MCT128	1 1/2 - 8	1200	1048	11.4
MCT212	2 - 12	1400	1357	15
MCT418	4 - 18	2209	1892	74



CHAIN WRENCH

CODE	SIZE INCH	⇒ Ø PIPE MM ⇐	Ø PIPE INCH	KG
MWC12	12	110	4"	0.85



HEAVY DUTY CHAIN WRENCHES

CODE	SIZE INCH	⇒ Ø PIPE MM ⇐	CHAIN LENGTH-MM	KG
MWC14	14	50-125	460	1.2
MWC18	18	60-125	500	2.5
MWC24	24	75-125	500	3.6
MWC36	36	110-185	760	6.8



HAND + POWER SPINNER



Drain Size: Cleans drain lines from 20mm-75mm [3/4"-3"] in diameter.



Unique design : Can connect with any Power drills or spin the drum manually.

Flexible soft shafts : are put in large metal drum to ensure cleaner and more convenient use.

Auto-Feed : It allows cable to self-feed down the drain.

Simple in structure and easy-to-handle: Release the locking screw, insert a soft shaft of certain length into the pipe. latch the lock and rotate the handle, and press it, repeated operation will easily remove the pipe blockages.

It can also be driven by any Power drills.

CODE	Ø CAPACITY	CABLE SIZE	KGS
DCM-25	3/4"-3"	Ø8MM-7.6M	3.2
DCM-35	3/4"-3"	Ø8MM-10.7M	4

FORCE PUMP

CODE	DESCRIPTION	KGS
PDCM-10A	Super pump + adaptor 1 + 2 + 3	2.2



Adaptor 1, 2 and 3



PNEUMATIC PUMP

CODE	DESCRIPTION	KGS
PDCM-10GQ	Pneumatic Pump 0.7Mpa + Air release extension pipe + adaptor and connector.	3.8



PIPE TOOLS / DRAIN CLEANING

DRAIN CLEANING MACHINE , XDM-K50

- XDM-K50 is Lightweight, strong, versatile and Portable design suitable for drain lines of Ø20-100mm (3/4"- 4") .
- Uses different cables of Ø8mm (5/16") and 16mm(5/8)". Soft shaft MF-2-A Ø8mm (5/16") best for Ø20-50mm drains.
- Uses Sectional Helical flexible shaft Ø16mm (5/8) best for Ø32-100mm(1-1/4"-4"). The sectional cables can be extended as required.
- Cable clutch ensures operator control, pull handle down and cable spins speed at 400 RPM, and the soft shaft stops when the handle is released.
- Equipped with 390W motor.
- Rated Voltage:220V (110V optional) 50Hz,60Hz.



STANDARD SUPPLY—XDM-K50

CODE	DESCRIPTION
XDM-K50	Drain cleaner Machine (110Volt or 220Volt - 50/60Hz) 390W
MRH1-1	7-Sections of MR-4-1 (Ø16mm×2.3m sectional cable) 52Ft 1-Pc of MR-3-1 (Ø16mm×2.3m flexible cable) 1-Pc of MF-1-F (Ø430 cable holder)
MZHA-1	8-Pc set of auger & cutter Ø16mm(MT-1-A MT-2-A MT-3-A MT-5-A MT-6-A MT-7-A MT-8-A MT-9-A)
MF-3-A	1-Pc of Ø4 Key
MF-2-A	1-Pc Ø8mm x 5M soft shaft combination
MF-5-A	1-Pc Protection gloves
MF-6-A	1-Pc Accessory barrel

CODE: MRH1-1
7-Sections of MR-4-1 (Ø16mm×2.3m soft shafts) Total 52Ft 1-Pc of MR-3-1 (Ø16mm×2.3m flexible soft shafts 1-Pc of MF-1-F (Ø430 cable holder)

CODE: MF-2-A
Ø8mm x 5M soft

CODE: MZHA-1
8-Pcs of drill set

CODE: MF-7-A
Protection tube ☑ Optional

CODE: MF-5-A
Protection

CODE: MF-2-A
Key Ø4mm

CODE: MF-6-A
Accessory barrel

MT-1-A	MT-2-A	MT-3-A	MT-5-A	MT-6-A	MT-7-A	MT-8-A	MT-9-A
Straight auger	Bulb auger-A	Bulb auger-B	Retrieving	4 blade cutter	Grease cutter	Saw-tooth	C-cutter

PIPE TOOLS / DRAIN CLEANING

DRAIN CLEANING MACHINE , XDM-K150

- XDM-K150 is multifunctional and strong design suitable for drain lines of Ø20-150mm (3/4" - 6") .
- Uses different cables of Ø8mm (5/16") ; 16mm(5/8") and Ø22mm(7/8") .
- Ø8mm cable best for 20-70mm pipes, Ø16mm best for 32-100mm pipes, and Ø22mm use for 50-150mm pipes.
- Cable clutch ensures operator control, pull handle down and cable spins speed at 400 RPM, and the soft shaft stops when the handle is released.
- Support is provided to adjust the height angle of the machine for different work environment.
- Equipped with 570W motor.
- Rated Voltage:220V (110V optional) 50Hz,60Hz.



STANDARD SUPPLY—XDM-K150

CODE	DESCRIPTION
XDM-K150	Drain cleaner Machine (110Volt or 220Volt - 50/60Hz) 570W
MRH1-3	1 x MR-3-1 (Ø16mm x 2.3M soft Flexible cable) 5 x MR-4-1 (Ø16mm x 2.3M sectional cables) 1x MF-1F Ø430 cable holder
MRH2-1	3 x MR-4-2 (Ø22mm x 4.6m Soft flexible cable & MF-1F holder
MZHA-3	4 - Pcs of auger & cutter Ø16mm(MT-1-A MT-3-A MT-5-A MT-6-A)
MZHB-1	4 - Pcs of auger & cutter Ø22mm(MT-1-B MT-4-B MT-6-B MT-7-B)
MF-3-A / B	1-Pc of MF-3-A Ø4mm Key & MF-3-B Ø5.5mm key
MF-2-B	1-Pc Ø8mm x 5M soft shaft combination
MF-5-A	1-Pc Protection gloves
MF-6-A	1-Pc Accessory barrel
MF-7-C	Protection tube 1.8M <input checked="" type="checkbox"/> Optional

CODE: MRH1-3





5-Sections of MR-4-1 (Ø16mm×2.3m sectional cables) Total 11.5M
1 X MR-3-1 (Ø16mm×2.3m) flexible cables
1 X MF-1-F (Ø430 cable holder)

CODE: MRH2-1

3 X Sections of MR-4-2 (Ø22mm×2.3m cables) Total 6.9M
1 X MF-1-F (Ø430 cable holder)

MT-1-A	MT-3-A	MT-5-A	MT-6-A
Straight auger	Bulb auger-Flexible	Retrieving Auger	4 Blade cutter

XDM-K150 ACCESSORIES

MT-1-B	MT-4-B	MT-6-B	MT-7-B
Straight auger	Funnel Auger	4 blade cutter	Grease cutter
			

CODE: MZHA-3
4-Pcs of drill set

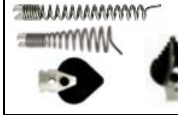

CODE: MZHB-1
4-Pcs of drill set

CODE: MF-2-B
Ø8mm x 5M soft

CODE: MF-5-A
Protection

CODE: MF-7-C
Protection tube ☑ Optional

CODE:MF-3-A
Key Ø5mm

CODE:MF-3-B
Key Ø4mm

CODE: MF-6-A
Accessory

AUTOMATIC DRUM TYPE DRAIN CLEANER, -XDM-K100A





- XDM-K100A is applicable for drain lines of Ø32-100mm (1-1/4"- 4") .
- Automatic cable feed powers the cable into and out of the drain. The direction of the feed device is reversed and the cable is returned to the drum.
- Built-in with ground fault circuit interrupter and air footswitch for more easy & safe operation.
- Drum spins at 300RPM, Equipped with 390W motor.
- Built with 8"rubber wheels and removable handle. Entirely sealed structure and the shafts are comfortably put in the drum.
- Rated Voltage:220V (110V optional) 50Hz,60Hz.



STANDARD SUPPLY—XDM-K100A

CODE	DESCRIPTION
XDM-K100A	Drain cleaner Machine (110Volt or 220Volt - 50/60Hz) 390W
MR-8-1	Ø12.7mm X 15M (1/2" x 50') inner cable
MF-9-J	Automatic feed device
MZHA-6	4 - Pcs of auger &cutter Ø16mm (MT-7-F MT-9-F MT-2-F MT-8-F)

MZHA-6

MT-7-F	MT-9-F	MT-2-F	MT-8-F
Grease cutter	C- cutter	Bulb auger	Side cutter
			

PIPE TOOLS / DRAIN CLEANING

POWER DRAIN CLEANING MACHINE, -XDM-K200

- XDM-K200 is applicable for all kind of outdoor drains of Ø50-200mm (2"- 8") . It is heavy-duty and unit has wheels to move.
- Inbuilt drill hanging rack for keeping augers and cutters.
- Uses Ø30mm cable (1-1/4") for drains 50-200mm . Cables are extendable.
- Cable clutch ensures operator control, pull handle down and cable spins speed at 700 RPM, and the soft shaft stops when the handle is released.
- Equipped with 1100W motor.
- Rated Voltage:220V (110V optional) 50Hz,60Hz.



STANDARD SUPPLY—XDM-K200

CODE	DESCRIPTION
XDM-K200	Drain cleaner Machine (110Volt or 220Volt - 50/60Hz) 1100W
MRH3-1	4 x MR-4-3 (Ø30mm x 4.6M sectional cables) 1x MF-1G Ø500 cable holder
MZHC-1	6 Pieces of auger & cutter Ø30mm(MT-1-C MT-4-C MT-5-C MT-7-C MT-8-C MT-9-C)
MF-3-B	1 X Ø5.5mm key
MF-5-A	1 X Protection gloves
MF-7-B	1 X Protection tube
MF-9-A	Accessories shelf

CODE: MRH3-1

4 x MR-4-3 (Ø30mm x 4.6M sectional cables)
1x MF-1G Ø500 cable holder

MZHC-1

MT-1-C	MT-4-C	MT-5-C	MT-7-C	MT-8C	MT-9-C
Straight auger	Funnel Auger	Retrieving Auger	Grease cutter	Sawtooth cutter	C- cutter

PIPE BEVELING MACHINE, M-BEVELER

The ID mounted Macstroc PIPE BEVELING MACHINES are Handy and lightweight portable beveller designed to create a perfect weld prep edge prior to joining. Machines be used efficiently by a single operator onsite, suitable for facing and bevel all type of pipe ends, pressure vessel and flanges. The “T” shape design of machines to work in the minimal radial working space. The machine is applicable in various grades of metal pipes, such as carbon steel, stainless steel and alloy steel.



PNEUMATIC MOTOR MPB-A
AIR working pressure: 0.8mpa
Air consuming flux : 25L/S
Motor Speed : 9200/rpm
Power: 1.4KW
Torque : 2.4NM
(air supply must be equipped with filtration and lubrication unit)



ELECTRIC VERSION 	PNEUMATIC VERSION 	CLAMPING RANGE Ø 	MAX. WALL THICKNESS-MM 	MAX OD Ø MM 	VOLTAGE KW RPM 	KGS ELECTRIC AIR
MPB79E	MPB79A	Ø26-79mm 1.02"-3.11"	15	89mm	220V 50/60HZ 1.43KW 70 R/min	11 9
MPB105E	MPB105A	Ø45-105mm 1.77"- 4.13"	15	125mm	220V 50/60HZ 1.43KW 34 R/min	22 21
MPB170E	MPB170A	Ø60-170mm 2.36"-6.69"	20	195mm	220V 50/60HZ 1.43KW 34 R/min	27 26

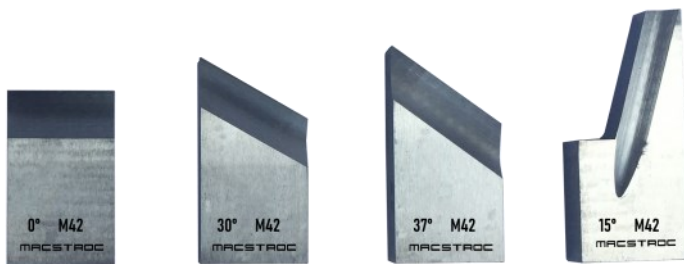

STANDARD TOOLS

DESCRIPTION	CODE M35	CODE M42 - SS
Tool 0°	MBT-035	MBT-042
Tool 15°	MBT-1535	MBT-1542
Tool 30°	MBT-3035	MBT-3042
Tool 37°	MBT-3735	MBT-3742



INDUSTRIAL CUT-OFF SAWS 16" (400MM)



Macstroc® cut-off saws are built purely for industrial use, with heavy-duty 3PH or 1PH induction motors and 400MM Abrasive wheel useful in various industries. High power motor provides outstanding performance for cutting of materials with high toughness and tenacity. The machine can cut directly at 90°, or unilaterally cut 45° to 90°, left and right.



CUT-OFF MACHINE — 3 PH - 16" (400MM)

CONFIG.	CODE [MC16SB-2]	CODE [MC16SB-4]
POWER	2.2KW	4 KW
MOTOR	3 HP induction	5.5 HP induction
VOLTAGE	3PH/400V 50Hz 4.6A	3PH/400V 50Hz 7.5A
SPINDLE SPEED	3000rpm	3000rpm
DISC SIZE	16"Ø400MMX Ø25.4	16"Ø400MMX Ø25.4
WORKBENCH SIZE	520x306	625x335
	CAPACITY MS	
BARØ	45MM	75MM
PIPE Ø	140MM	150MM
SHAPED STEEL	110MM	150MM
N.W/G.W	44/47kg	71/84kg

CUT-OFF MACHINE — 1 PH - 16" (400MM)

CONFIG.	CODE [MC16-A1]	CODE [MC16-A2]
POWER	2.2 KW	3 KW
MOTOR	3 HP induction	4 HP induction
VOLTAGE	1PH /220V 50-60Hz 13.5A	1PH/220V 50-60Hz 16.5A
SPINDLE SPEED	3000-3380rpm	3000-3380rpm
DISC SIZE	16"Ø400MMX Ø25.4	16"Ø400MMX Ø25.4
WORKBENCH SIZE	520x306	585x335
	CAPACITY MS	
BARØ	40MM	45MM
PIPE Ø	130MM	140MM
SHAPED STEEL	110MM	115MM
N.W/G.W	44/47kg	59/62kg

PERMANENT LIFTING MAGNETS



Safety factor 3.5+
 Certified safety (Supplied with COC)
 Suitable for flat and round objects
 Suitable for rough or finished surfaces and temperatures up to 80°C / 176 °F
 Maintenance free
 Reliable and consistent performance under extreme conditions
 Easy and single handle operation.

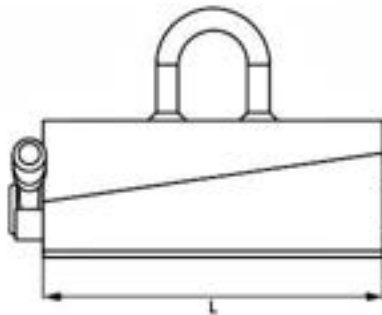
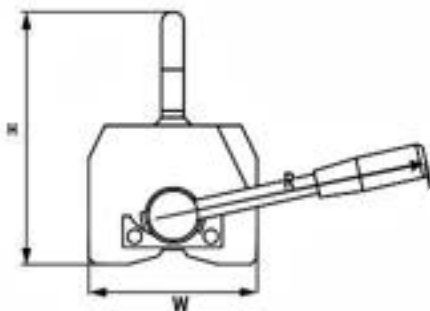
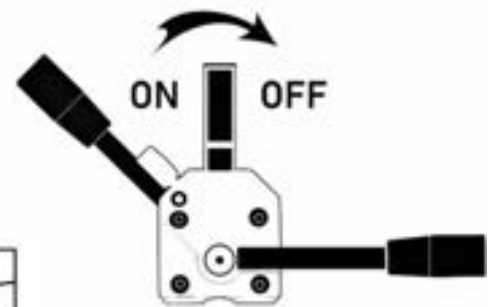

CODE	Rated Lifting Strength (KGF)	Cylindrical Lifting Strength (KGF)	Max. Pull Off Strength (KGF)	L MM	W MM	H MM	R MM	Working (°C)	Safety	KG
MSWL125	125	65	437.5	138	60	118.5	136	<80	3.5+	3.3
MSWL250	250	125	875	168	80	151	136	<80	3.5+	7.2
MSWL500	500	250	1750	228	100	180	150	<80	3.5+	15.5
MSWL1000	1000	500	3500	307	170	266	284	<80	3.5+	55
MSWL2000	2000	1000	7000	413	200	387.5	334	<80	3.5+	110
MSWL3000	3000	1500	10500	546	230	451	581	<80	3.5+	220
MSWL5000	5000	2500	17500	734	430	496	814	<80	3.5+	440

MAGNETIC DRILLING MACHINE 35MM, STROC.35HV

Macstroc® Magnetic drill model ‘STROC.35HV’ for industrial use, it has a cutting capacity of up to 35mm with an integral auto-cooling function and a powerful new hi-torque motor.

KEY FEATURES

- Variable Speed
- Extendable height up to 220mm from work piece to spindle, enables to attach twist drill chuck and other accessories easily.
- High accuracy and low maintenance
- Minimal vibration, weighs only 11kg

TECHNICAL DATA	
Annular cutting	Ø12-35 mm
Twist drilling	Ø1-16 mm
Countersinking	Ø10-40 mm
Length & width	210 & 290 mm
Height	380-590mm
Stroke	220 mm
Magnetic force	1300 KG
Magnet [L x W x H]	165 x 85 x 50 mm
Motor Power	1100W
Total Power	1150W
Speed (no load)	200-750 R/min
Spindle	19.5mm [Weldon]
Voltage	220-240V / 50-60Hz 110-120V /50-60Hz
Weight	11 kgs.



OPTIONAL ACCESSORIES

CODE	DESCRIPTION
CHUK13-A	13MM / 1/2"x20 UNF keyless
MZXU-01	Adapter For twist-drill chuck 1/2" x 20 UNF - WELDON
MPAK-01	Pipe adapter kit 22x12 CM Chain length 29 CM



MAGNETIC DRILLING MACHINE 50MM, STROC.50HV

Macstroc® industrial Mag-drill 'STROC.50HV' has a cutting capacity of up to 50mm with stepdown gear box , integral auto-cooling function, and supplied with external cooling device. STROC.50HV is equipped with a powerful motor, variable speed function, and the design ensures stable support, faster drilling times and more accurate hole sizing.

KEY FEATURES

- Variable Speed , Step down gear box
- Stroke up to 220mm from work piece to spindle, enables to attach twist drill chuck and other accessories easily.
- Ensures stable support, faster drilling, low maintenance.
- Minimal vibration, high accuracy and more cutter life.
- MT3 spindle with integrated tool cooling and lubrication



CODE	DESCRIPTION
MPAK-01	pipe adapter kit fixed base 22x12 CM Chain length 29 CM (*Optional)
MAPK-02	pipe adapter kit tilt base 22x12 CM Chain length 29 CM (*Optional)
SF4849	1 GAL, Water soluble multipurpose cutting oil made from virgin base oil. (*Optional)



TECHNICAL DATA	
Annular cutting	Ø12-50 mm
Twist drilling	Ø1-27mm
Countersinking	Ø10-55 mm
Length & width	210 & 360 mm
Height	440-650mm
Maximum open from spindle to work piece	220mm
Stroke	220 mm
Magnetic force	1400 KG
Magnet [L x W x H]	200 x 110 x 65 mm
Motor Power	1700W
Speed (no load)	200-650 R/min
Spindle	MT-3 MT-2
Voltage	220 -240V / 50-60Hz or 110V 50-60Hz
Weight	19 Kgs

OPTIONAL ACCESSORIES

CODE	DESCRIPTION
ABR.3-B16	Arbor MT-3 - B16
CHUK16-B16	Twist drill chuck 16mm with key



CODE	DESCRIPTION
CHUK13-A	13MM / 1/2"x20 UNF keyless
MZXU-01	Adapter For twist-drill chuck 1/2" x 20 UNF - WELDON



AUTOMATIC MAG-DRILL 50MM, STROC.51A

Macstroc® industrial Mag-drill 'STROC.51A' is 'Auto-feed' with the highest efficiency, Cutting capacity of up to 50mm, integral auto-cooling, and supplied with external cooling device. STROC.51A is Heavy-duty, ensures stable support, longer life span, and more safe.



TECHNICAL DATA	
Annular cutting	Ø12-50 mm
Twist drilling	Ø1-28mm
Countersinking	Ø10-60 mm
Length & width	270 & 350 mm
Height	500-650mm
Stroke	150 mm
Magnetic force	1400 KG
Magnet [L x W x H]	200 x 96 x 60 mm
Motor Power	1700W
Speed (no load)	650 R/min
Spindle	MT-3
Voltage	220 -240V / 50-60Hz or 110V 50-60Hz
Weight	19 Kgs

LOW PROFILE MAGNETIC DRILL, STROC.LP50X

Macstroc® industrial Mag-drill 'STROC.LP50X' is perfect for drilling in spaces with limited heights. It is equipped with a powerful motor, 6 speed regulating gears, lock feed handle for both left and right operation.



TECHNICAL DATA	
Annular cutting	Ø12-50 mm
Twist drilling	Ø1-12 mm
Countersinking	Ø10-40 mm
Length & width	360 & 90 mm
Height	180 mm
Stroke	61mm
Magnetic force	950 KG
Magnet [L x W x H]	90 x 80 x 45 mm
Total Power	1300W
Speed (no load)	200-500 R/min
6-Speed regulation	1-200 ; 2-300 3=350; 4=415 5=485; 6=500
Spindle	19.5mm [Weldon]
Voltage	220-240V / 50-60Hz 110-120V /50-60Hz
Weight	11 Kgs

MAGNETIC DRILL W/TAPPING 60MM, STROC.60HVT

Macstroc® industrial Mag-drill 'STROC.60HVT' is suitable for both drilling and tapping. Cutting capacity of up to 60mm with stepdown gear box , integral auto-cooling function, and supplied with external cooling device. Heavy-duty, variable speed function, and the design ensures stable support, faster drilling times , more accurate hole sizing and more cutter life.

KEY FEATURES

- Variable Speed , Step down gear box, reverse function for tapping.
- Stroke up to 220mm from work piece to spindle, enables to attach twist drill chuck and other accessories easily.
- Ensures stable support, faster drilling, low maintenance.
- Minimal vibration, high accuracy and more cutter life.
- MT3 spindle with integrated tool cooling and lubrication and external cooling device



CODE	DESCRIPTION
MPAK-01	pipe adapter kit 22x12 CM Chain length 29 CM (*Optional)
MAPK-02	pipe adapter kit tilt base 22x12 CM Chain length 29 CM (*Optional)
SF4849	1 GAL, Water soluble multipurpose cutting oil made from virgin base oil. (*Optional)



TECHNICAL DATA	
Annular cutting	Ø12-60 mm
Tapping	M20-M27
Twist drilling	Ø1-28mm
Countersinking	Ø10-70 mm
Length & width	210 & 360 mm
Height	440-650mm
Maximum open from spindle to work piece	220mm
Stroke	220 mm
Magnetic force	1850 KG
Magnet [L x W x H]	200 x 110 x 65 mm
Motor Power	1800W
Speed (no load)	200-600 R/min
Spindle	MT-3 /MT-2
Voltage	220 -240V / 50-60Hz or 110V 50-60Hz
Weight	20 Kgs

OPTIONAL ACCESSORIES

CODE	DESCRIPTION
ABR.3-B16	Arbor MT-3 - B16
CHUK16-B16	Twist drill chuck 16mm with key



CODE	DESCRIPTION
CHUK13-A	13MM / 1/2"x20 UNF keyless
MZXU-01	Adapter For twist-drill chuck 1/2" x 20 UNF - WELDON



METAL WORKING TOOLS / MAG-DRILL



QUALITY DEFINED

MAGNETIC DRILL 75MM, STROC.75T

Macstroc® industrial Mag-drill 'STROC.75T' is suitable for both drilling and tapping. Cutting capacity of up to 75mm with 2-speed mechanical gear box, integral auto-cooling function.



TECHNICAL DATA	
Annular cutting	Ø 12 - 75 mm
Twist drilling	Ø 1 - 31.75 mm
Countersinking	Ø 10 - 105 mm
Tapping	M3 - M30
Length & Width	400 mm x 230 mm
Height	580 - 710 mm
Stroke	210 mm
Weight	22 kg
Magnet [L x W x H]	220 x 110 x 60 mm
Magnetic force	1800KG
Motor power	1800 W
Speed (no load)	260/460 rpm
Spindle (Weldon)	MT-3 [19,05 / 31.75mm]
Voltage	220 - 240 V / 50 - 60

MAGNETIC DRILL 120MM, WITH TAPPING MT-4 ARBOR, STROC.120



TECHNICAL DATA	
Annular cutting	Ø 12 - 120 mm
Twist drilling	Ø 38mm
Countersinking	Ø 10 - 120 mm
Tapping	M3-M42
Length	440 mm
Width	230 mm
Height	660 - 750 mm
Stroke	210 mm
Magnet (l x w x h)	330 x 110 x 60 mm
Magnetic force	2400KG
Motor power	1800 W / 2050 W
Speed (no load)	82/180/245/535 RPM
Spindle (Weldon)	MT-4 / MT-3 [19,05 / 31.75mm]
Voltage	110 - 120 V / 60 Hz 220 - 240 V / 50-60 Hz
Weight	33 kgs

HSS ANNULAR CUTTERS –30MM LONG, MACSHANK

MAC-SHANK Annular cutters from MACSTROC, which is a combination of "Weldon-shank" and "Universal-shank" Annular cutters. It has set 90° Flats for grub screws in traditional "Weldon-shank" machines and one-touch grooves for Quick connect. Macstroc annular cutters are superior with it's quality which provide 2X life and the fastest cut. It fits into 90% of Magnetic drilling machines, as well as other stationary machines. A special formula used in the cutters, reduces the risk of breakages.

MAC - S SERIES 30MM LENGTH

CODE	SIZE DIA Ø	CODE	SIZE DIA Ø
MAC.12S	Ø12	MAC.32S	Ø32
MAC.13S	Ø13	MAC.33S	Ø33
MAC.14S	Ø14	MAC.34S	Ø34
MAC.15S	Ø15	MAC.35S	Ø35
MAC.16S	Ø16	MAC.36S	Ø36
MAC.17S	Ø17	MAC.37S	Ø37
MAC.18S	Ø18	MAC.38S	Ø38
MAC.19S	Ø19	MAC.39S	Ø39
MAC.20S	Ø20	MAC.40S	Ø40
MAC.21S	Ø21	MAC.41S	Ø41
MAC.22S	Ø22	MAC.42S	Ø42
MAC.23S	Ø23	MAC.43S	Ø43
MAC.24S	Ø24	MAC.44S	Ø44
MAC.25S	Ø25	MAC.45S	Ø45
MAC.26S	Ø26	MAC.46S	Ø46
MAC.27S	Ø27	MAC.47S	Ø47
MAC.28S	Ø28	MAC.48S	Ø48
MAC.29S	Ø29	MAC.49S	Ø49
MAC.30S	Ø30	MAC.50S	Ø50
MAC.31S	Ø31	MAC.51S	Ø51

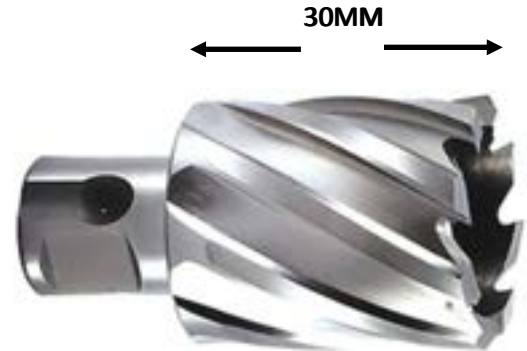

CODE	SIZE DIA Ø
MAC.52S	Ø52
MAC.53S	Ø53
MAC.54S	Ø54
MAC.55S	Ø55
MAC.56S	Ø56
MAC.57S	Ø57
MAC.58S	Ø58
MAC.59S	Ø59
MAC.60S	Ø60
MAC.61S	Ø61
MAC.62S	Ø62
MAC.63S	Ø63
MAC.64S	Ø64
MAC.65S	Ø65



PILOT PIN
CODE : MPD.30
SIZE: 77 x 6.35MM

MAC-SHANK CUTTERS CAN BE USED INTO 90% OF THE MAG DRILLS

HSS ANNULAR CUTTERS -55MM LONG, MACSHANK

CODE	SIZE DIA Ø	CODE	SIZE DIA Ø
MAC.12L	Ø12	MAC.32L	Ø32
MAC.13L	Ø13	MAC.33L	Ø33
MAC.14L	Ø14	MAC.34L	Ø34
MAC.15L	Ø15	MAC.35L	Ø35
MAC.16L	Ø16	MAC.36L	Ø36
MAC.17L	Ø17	MAC.37L	Ø37
MAC.18L	Ø18	MAC.38L	Ø38
MAC.19L	Ø19	MAC.39L	Ø39
MAC.20L	Ø20	MAC.40L	Ø40
MAC.21L	Ø21	MAC.41L	Ø41
MAC.22L	Ø22	MAC.42L	Ø42
MAC.23L	Ø23	MAC.43L	Ø43
MAC.24L	Ø24	MAC.44L	Ø44
MAC.25L	Ø25	MAC.45L	Ø45
MAC.26L	Ø26	MAC.46L	Ø46
MAC.27L	Ø27	MAC.47L	Ø47
MAC.28L	Ø28	MAC.48L	Ø48
MAC.29L	Ø29	MAC.49L	Ø49
MAC.30L	Ø30	MAC.50L	Ø50
MAC.31L	Ø31	MAC.51L	Ø51

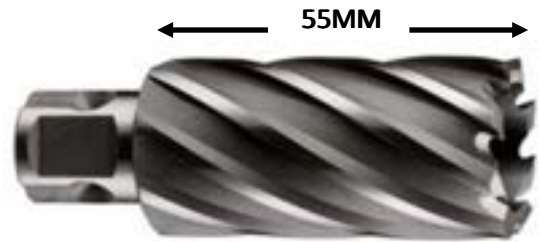

MAC L- SERIES 55MM LENGTH

CODE	SIZE DIA Ø
MAC.52L	Ø52
MAC.53L	Ø53
MAC.54L	Ø54
MAC.55L	Ø55
MAC.56L	Ø56
MAC.57L	Ø57
MAC.58L	Ø58
MAC.59L	Ø59
MAC.60L	Ø60
MAC.61L	Ø61
MAC.62L	Ø62
MAC.63L	Ø63
MAC.64L	Ø64
MAC.65L	Ø65



PILOT PIN

CODE : MPD.55

SIZE : 103 x 6.35MM

KNOW—WHAT IS MACSHANK ?

MACSHANK IS A COMBINATION OF A WELDON AND UNIVERSAL SHANK FOR ANNULAR CUTTERS. IT CAN BE USED IN 90% OF MAGNETIC DRILLS.

2X LIFE : IT HAS TWICE THE LIFESPAN, IS FASTER, AND REDUCES THE RISK OF BREAKAGE.

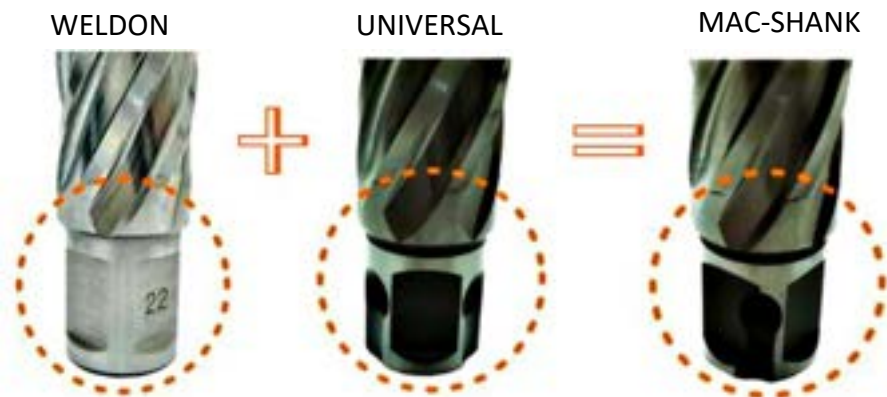

S - SERIES TCT ANNULAR CUTTERS 35MM

SHANK AVAILABLE IN WELDON OR UNIVERSAL



Macstroc tungsten carbide tipped (TCT) annular cutters are durable to use in hard and high tensile steel, stainless steel, rail steel as well as difficult materials, non-ferrous and alloys.

CODE	DIA Ø
MTT.12S	Ø12
MTT.13S	Ø13
MTT.14S	Ø14
MTT.15S	Ø15
MTT.16S	Ø16
MTT.17S	Ø17
MTT.18S	Ø18
MTT.19S	Ø19
MTT.20S	Ø20
MTT.21S	Ø21
MTT.22S	Ø22
MTT.23S	Ø23
MTT.24S	Ø24
MTT.25S	Ø25
MTT.26S	Ø26
MTT.27S	Ø27
MTT.28S	Ø28
MTT.29S	Ø29
MTT.30S	Ø30
MTT.31S	Ø31
MTT.32S	Ø32
MTT.33S	Ø33
MTT.34S	Ø34
MTT.35S	Ø35

CODE	DIA Ø
MTT.36S	Ø36
MTT.37S	Ø37
MTT.38S	Ø38
MTT.39S	Ø39
MTT.40S	Ø40
MTT.41S	Ø41
MTT.42S	Ø42
MTT.43S	Ø43
MTT.44S	Ø44
MTT.45S	Ø45
MTT.46S	Ø46
MTT.47S	Ø47
MTT.48S	Ø48
MTT.49S	Ø49
MTT.50S	Ø50
MTT.51S	Ø51
MTT.52S	Ø52
MTT.53S	Ø53
MTT.54S	Ø54
MTT.55S	Ø55
MTT.56S	Ø56
MTT.57S	Ø57
MTT.58S	Ø58

CODE	DIA Ø
MTT.59S	Ø59
MTT.60S	Ø60
MTT.61S	Ø61
MTT.62S	Ø62
MTT.63S	Ø63
MTT.64S	Ø64
MTT.65S	Ø65
MTT.66S	Ø66
MTT.67S	Ø67
MTT.68S	Ø68
MTT.69S	Ø69
MTT.70S	Ø70
MTT.71S	Ø71
MTT.72S	Ø72
MTT.73S	Ø73

CODE	DIA Ø
MTT.74S	Ø74
MTT.75S	Ø75
MTT.76S	Ø76
MTT.77S	Ø77
MTT.78S	Ø78
MTT.79S	Ø79
MTT.80S	Ø80
MTT.81S	Ø81
MTT.82S	Ø82
MTT.83S	Ø83
MTT.84S	Ø84
MTT.85S	Ø85
MTT.86S	Ø86
MTT.87S	Ø87
MTT.88S	Ø88

CODE	DIA Ø
MTT.89S	Ø89
MTT.90S	Ø90
MTT.91S	Ø91
MTT.92S	Ø92
MTT.93S	Ø93
MTT.94S	Ø94
MTT.95S	Ø95
MTT.96S	Ø96
MTT.97S	Ø97
MTT.98S	Ø98
MTT.99S	Ø99
MTT.100S	Ø100
MTT.101S	Ø101
MTT.102S	Ø102
MTT.103S	Ø103

PILOT PIN



CODE	SIZE	ANNULAR CUTTERS
MPDT.20	6.35 X 90 MM	Ø12 - Ø17 MM
MPDT.30	8 X 90 MM	Ø18 - Ø65 MM
MPDT.35	8 X 103 MM	Ø66 - Ø130 MM

L - SERIES TCT ANNULAR CUTTERS 55MM +

SHANK AVAILABLE IN WELDON OR UNIVERSAL



*Custom sizes up to Ø150MM in scope of supply. *TCT use in hard and high tensile steel, stainless steel, rail steel as well as difficult materials, non-ferrous and alloys.

CODE	DIA Ø
MTT.12L	Ø12
MTT.13L	Ø13
MTT.14L	Ø14
MTT.15L	Ø15
MTT.16L	Ø16
MTT.17L	Ø17
MTT.18L	Ø18
MTT.19L	Ø19
MTT.20L	Ø20
MTT.21L	Ø21
MTT.22L	Ø22
MTT.23L	Ø23
MTT.24L	Ø24
MTT.25L	Ø25
MTT.26L	Ø26
MTT.27L	Ø27
MTT.28L	Ø28
MTT.29L	Ø29
MTT.30L	Ø30
MTT.31L	Ø31
MTT.32L	Ø32
MTT.33L	Ø33
MTT.34L	Ø34
MTT.35L	Ø35

CODE	DIA Ø
MTT.36L	Ø36
MTT.37L	Ø37
MTT.38L	Ø38
MTT.39L	Ø39
MTT.40L	Ø40
MTT.41L	Ø41
MTT.42L	Ø42
MTT.43L	Ø43
MTT.44L	Ø44
MTT.45L	Ø45
MTT.46L	Ø46
MTT.47L	Ø47
MTT.48L	Ø48
MTT.49L	Ø49
MTT.50L	Ø50
MTT.51L	Ø51
MTT.52L	Ø52
MTT.53L	Ø53
MTT.54L	Ø54
MTT.55L	Ø55
MTT.56L	Ø56
MTT.57L	Ø57
MTT.58L	Ø58
MTT.59L	Ø59

CODE	DIA Ø
MTT.60L	Ø60
MTT.61L	Ø61
MTT.62L	Ø62
MTT.63L	Ø63
MTT.64L	Ø64
MTT.65L	Ø65
MTT.66L	Ø66
MTT.67L	Ø67
MTT.68L	Ø68
MTT.69L	Ø69
MTT.70L	Ø70
MTT.71L	Ø71
MTT.72L	Ø72
MTT.73L	Ø73
MTT.74L	Ø74
MTT.75L	Ø75
MTT.76L	Ø76
MTT.77L	Ø77

CODE	DIA Ø
MTT.78L	Ø78
MTT.79L	Ø79
MTT.80L	Ø80
MTT.81L	Ø81
MTT.82L	Ø82
MTT.83L	Ø83
MTT.84L	Ø84
MTT.85L	Ø85
MTT.86L	Ø86
MTT.87L	Ø87
MTT.88L	Ø88
MTT.89L	Ø89
MTT.90L	Ø90
MTT.91L	Ø91
MTT.92L	Ø92
MTT.93L	Ø93
MTT.94L	Ø94
MTT.95L	Ø95

CODE	DIA Ø
MTT.96L	Ø96
MTT.97L	Ø97
MTT.98L	Ø98
MTT.99L	Ø99
MTT.100L	Ø100
MTT.101L	Ø101
MTT.102L	Ø102
MTT.103L	Ø103
MTT.104L	Ø104
MTT.105L	Ø105
MTT.106L	Ø106
MTT.107L	Ø107
MTT.108L	Ø108
MTT.109L	Ø109
MTT.110L	Ø110
MTT.115L	Ø115
MTT.120L	Ø120
MTT.125L	Ø125

PILOT PIN



CODE	SIZE	ANNULAR CUTTERS
MPDT.40	6.35 X 106 MM	Ø12 - Ø17 MM
MPDT.50	8 X 108 MM	Ø18 - Ø65 MM
MPDT.55	8 X 115 MM	Ø66 - Ø130 MM

Y - SERIES TCT ANNULAR CUTTERS 75-80MM

SHANK AVAILABLE IN WELDON OR UNIVERSAL

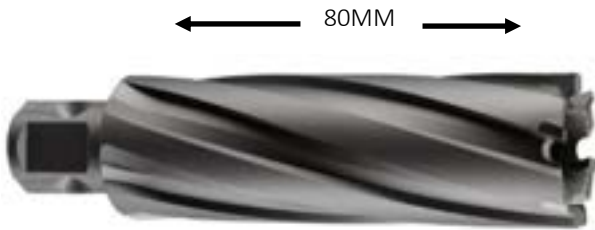

*Custom sizes up to Ø150MM in scope of supply. *TCT use in hard and high tensile steel, stainless steel, rail steel as well as difficult materials, non-ferrous and alloys.

CODE	DIA Ø
MTT.12Y	Ø12
MTT.13Y	Ø13
MTT.14Y	Ø14
MTT.15Y	Ø15
MTT.16Y	Ø16
MTT.17Y	Ø17
MTT.18Y	Ø18
MTT.19Y	Ø19
MTT.20Y	Ø20
MTT.21Y	Ø21
MTT.22Y	Ø22
MTT.23Y	Ø23
MTT.24Y	Ø24
MTT.25Y	Ø25
MTT.26Y	Ø26
MTT.27Y	Ø27
MTT.28Y	Ø28
MTT.29Y	Ø29
MTT.30Y	Ø30
MTT.31Y	Ø31
MTT.32Y	Ø32
MTT.33Y	Ø33
MTT.34Y	Ø34
MTT.35Y	Ø35
MTT.36Y	Ø36
MTT.37Y	Ø37

CODE	DIA Ø
MTT.38Y	Ø38
MTT.39Y	Ø39
MTT.40Y	Ø40
MTT.41Y	Ø41
MTT.42Y	Ø42
MTT.43Y	Ø43
MTT.44Y	Ø44
MTT.45Y	Ø45
MTT.46Y	Ø46
MTT.47Y	Ø47
MTT.48Y	Ø48
MTT.49Y	Ø49
MTT.50Y	Ø50
MTT.51Y	Ø51
MTT.52Y	Ø52
MTT.53Y	Ø53
MTT.54Y	Ø54
MTT.55Y	Ø55
MTT.56Y	Ø56
MTT.57Y	Ø57
MTT.58Y	Ø58
MTT.59Y	Ø59
MTT.60Y	Ø60
MTT.61Y	Ø61
MTT.62Y	Ø62

CODE	DIA Ø
MTT.63Y	Ø63
MTT.64Y	Ø64
MTT.65L	Ø65
MTT.66Y	Ø66
MTT.67Y	Ø67
MTT.68Y	Ø68
MTT.69Y	Ø69
MTT.70Y	Ø70
MTT.71Y	Ø71
MTT.72Y	Ø72
MTT.73Y	Ø73
MTT.74Y	Ø74
MTT.75Y	Ø75
MTT.76Y	Ø76
MTT.77Y	Ø77
MTT.78Y	Ø78
MTT.79Y	Ø79
MTT.80Y	Ø80

CODE	DIA Ø
MTT.81Y	Ø81
MTT.82Y	Ø82
MTT.83Y	Ø83
MTT.84Y	Ø84
MTT.85Y	Ø85
MTT.86Y	Ø86
MTT.87Y	Ø87
MTT.88Y	Ø88
MTT.89Y	Ø89
MTT.90Y	Ø90
MTT.91Y	Ø91
MTT.92Y	Ø92
MTT.93Y	Ø93
MTT.94Y	Ø94
MTT.95Y	Ø95
MTT.96Y	Ø96
MTT.97Y	Ø97
MTT.98Y	Ø98

CODE	DIA Ø
MTT.99Y	Ø99
MTT.100Y	Ø100
MTT.101Y	Ø101
MTT.102Y	Ø102
MTT.103Y	Ø103
MTT.104Y	Ø104
MTT.105Y	Ø105
MTT.106Y	Ø106
MTT.107Y	Ø107
MTT.108Y	Ø108
MTT.109Y	Ø109
MTT.110Y	Ø110
MTT.115Y	Ø115
MTT.120Y	Ø120
MTT.125Y	Ø125
MTT.130Y	Ø130
MTT.140Y	Ø140
MTT.150Y	Ø150

PILOT PIN



CODE	SIZE	ANNULAR CUTTERS
MPD.70	6.35 X 130 MM	Ø12 – Ø17 MM
MPDT.70	8 X 130 MM	Ø18 – Ø65 MM
MPDT.75	8 X 145 MM	Ø66 – Ø130 MM

X – SERIES TCT ANNULAR CUTTERS 100-110MM

SHANK AVAILABLE IN WELDON OR UNIVERSAL



*Custom sizes up to \varnothing 150MM in scope of supply. *TCT use in hard and high tensile steel, stainless steel, rail steel as well as difficult materials, non-ferrous and alloys.

CODE	DIA \varnothing
MTT.12X	\varnothing 12
MTT.13X	\varnothing 13
MTT.14X	\varnothing 14
MTT.15X	\varnothing 15
MTT.16X	\varnothing 16
MTT.17X	\varnothing 17
MTT.18X	\varnothing 18
MTT.19X	\varnothing 19
MTT.20X	\varnothing 20
MTT.21X	\varnothing 21
MTT.22X	\varnothing 22
MTT.23X	\varnothing 23
MTT.24X	\varnothing 24
MTT.25X	\varnothing 25
MTT.26X	\varnothing 26
MTT.27X	\varnothing 27
MTT.28X	\varnothing 28
MTT.29X	\varnothing 29
MTT.30X	\varnothing 30
MTT.31X	\varnothing 31
MTT.32X	\varnothing 32
MTT.33X	\varnothing 33
MTT.34X	\varnothing 34
MTT.35X	\varnothing 35
MTT.36X	\varnothing 36
MTT.37X	\varnothing 37

CODE	DIA \varnothing
MTT.38X	\varnothing 38
MTT.39X	\varnothing 39
MTT.40X	\varnothing 40
MTT.41X	\varnothing 41
MTT.42X	\varnothing 42
MTT.43X	\varnothing 43
MTT.44X	\varnothing 44
MTT.45X	\varnothing 45
MTT.46X	\varnothing 46
MTT.47X	\varnothing 47
MTT.48X	\varnothing 48
MTT.49X	\varnothing 49
MTT.50X	\varnothing 50
MTT.51X	\varnothing 51
MTT.52X	\varnothing 52
MTT.53X	\varnothing 53
MTT.54X	\varnothing 54
MTT.55X	\varnothing 55
MTT.56X	\varnothing 56
MTT.57X	\varnothing 57
MTT.58X	\varnothing 58
MTT.59X	\varnothing 59
MTT.60X	\varnothing 60
MTT.61X	\varnothing 61
MTT.62X	\varnothing 62
MTT.63X	\varnothing 63

CODE	DIA \varnothing
MTT.64X	\varnothing 64
MTT.65X	\varnothing 65
MTT.66X	\varnothing 66
MTT.67X	\varnothing 67
MTT.68X	\varnothing 68
MTT.69X	\varnothing 69
MTT.70X	\varnothing 70
MTT.71X	\varnothing 71
MTT.72X	\varnothing 72
MTT.73X	\varnothing 73
MTT.74X	\varnothing 74
MTT.75X	\varnothing 75
MTT.76X	\varnothing 76
MTT.77X	\varnothing 77
MTT.78X	\varnothing 78
MTT.79X	\varnothing 79
MTT.80X	\varnothing 80
MTT.81X	\varnothing 81

CODE	DIA \varnothing
MTT.82X	\varnothing 82
MTT.83X	\varnothing 83
MTT.84X	\varnothing 84
MTT.85X	\varnothing 85
MTT.86X	\varnothing 86
MTT.87X	\varnothing 87
MTT.88X	\varnothing 88
MTT.89X	\varnothing 89
MTT.90X	\varnothing 90
MTT.91X	\varnothing 91
MTT.92X	\varnothing 92
MTT.93X	\varnothing 93
MTT.94X	\varnothing 94
MTT.95X	\varnothing 95
MTT.96X	\varnothing 96
MTT.97X	\varnothing 97
MTT.98X	\varnothing 98
MTT.99X	\varnothing 99

CODE	DIA \varnothing
MTT.100X	\varnothing 100
MTT.101X	\varnothing 101
MTT.101X	\varnothing 101
MTT.102X	\varnothing 102
MTT.103X	\varnothing 103
MTT.104X	\varnothing 104
MTT.105X	\varnothing 105
MTT.106X	\varnothing 106
MTT.107X	\varnothing 107
MTT.108X	\varnothing 108
MTT.109X	\varnothing 109
MTT.110X	\varnothing 110
MTT.115X	\varnothing 115
MTT.120X	\varnothing 120
MTT.125X	\varnothing 125
MTT.130X	\varnothing 130
MTT.140X	\varnothing 140
MTT.150X	\varnothing 150

PILOT PIN

CODE	SIZE	ANNULAR CUTTERS
MPD.150	6.35 X 150 MM	\varnothing 12 – \varnothing 17MM
MPDT.100	8 X 160 MM	\varnothing 18 – \varnothing 65MM
MPDT.180	8 X 180 MM	\varnothing 66 – \varnothing 130 MM

COBALT ANNULAR CUTTERS



Macstroc COBALT 5% grade M35 Annular cutters have additional cobalt added for much greater wear resistance, although harder, will give longer cutting life in mild steel and better performance in more difficult materials. The extra added cobalt enables to drill in Stainless steel tough & harder steel easily. Available in weldon shank and universal shank . Macstroc also produces 8% cobalt cutters with grade M42

← 35MM →

← 55MM →

CODE	DIA Ø
MCO.12S	Ø12MM
MCO.13S	Ø13MM
MCO.14S	Ø14MM
MCO.15S	Ø15MM
MCO.16S	Ø16MM
MCO.17S	Ø17MM
MCO.18S	Ø18MM
MCO.19S	Ø19MM
MCO.20S	Ø20MM
MCO.21S	Ø21MM
MOC.22S	Ø22MM
MCO.23S	Ø23MM
MCO.24S	Ø24MM
MCO.25S	Ø25MM
MCO.26S	Ø26MM
MCO.27S	Ø27MM
MCO.28S	Ø28MM
MCO.29S	Ø29MM
MCO.30S	Ø30MM
MCO.31S	Ø31MM
MCO.32S	Ø32MM
MCO.33S	Ø33MM
MCO.34S	Ø34MM
MCO.35S	Ø35MM
MCO.36S	Ø36MM
MCO.37S	Ø37MM

CODE	DIA Ø
MCO.38S	Ø38MM
MCO.39S	Ø39MM
MCO.40S	Ø40MM
MCO.41S	Ø41MM
MCO.42S	Ø42MM
MCO.43S	Ø43MM
MCO.44S	Ø44MM
MCO.45S	Ø45MM
MCO.46S	Ø46MM
MCO.47S	Ø47MM
MCO.48S	Ø48MM
MCO.49S	Ø49MM
MCO.50S	Ø50MM
MCO.51S	Ø51MM
MCO.52S	Ø52MM
MCO.53S	Ø53MM
MCO.54S	Ø54MM
MCO.55S	Ø55MM
MCO.56S	Ø56MM
MCO.57S	Ø57MM
MCO.58S	Ø58MM
MCO.59S	Ø59MM
MCO.60S	Ø60MM
MCO.61S	Ø61MM
MCO.62S	Ø62MM
MCO.63S	Ø63MM

CODE	DIA Ø
MCO.12L	Ø12MM
MCO.13L	Ø13MM
MCO.14L	Ø14MM
MCO.15L	Ø15MM
MCO.16L	Ø16MM
MCO.17L	Ø17MM
MCO.18L	Ø18MM
MCO.19L	Ø19MM
MCO.20L	Ø20MM
MCO.21L	Ø21MM
MOC.22L	Ø22MM
MCO.23L	Ø23MM
MCO.24L	Ø24MM
MCO.25L	Ø25MM
MCO.26L	Ø26MM
MCO.27L	Ø27MM
MCO.28L	Ø28MM
MCO.29L	Ø29MM
MCO.30L	Ø30MM
MCO.31L	Ø31MM
MCO.32L	Ø32MM
MCO.33L	Ø33MM
MCO.34L	Ø34MM
MCO.35L	Ø35MM
MCO.36L	Ø36MM
MCO.37L	Ø37MM

CODE	DIA Ø
MCO.38L	Ø38MM
MCO.39L	Ø39MM
MCO.40L	Ø40MM
MCO.41L	Ø41MM
MCO.42L	Ø42MM
MCO.43L	Ø43MM
MCO.44L	Ø44MM
MCO.45L	Ø45MM
MCO.46L	Ø46MM
MCO.47L	Ø47MM
MCO.48L	Ø48MM
MCO.49L	Ø49MM
MCO.50L	Ø50MM
MCO.51L	Ø51MM
MCO.52L	Ø52MM
MCO.53L	Ø53MM
MCO.54L	Ø54MM
MCO.55L	Ø55MM
MCO.56L	Ø56MM
MCO.57L	Ø57MM
MCO.58L	Ø58MM
MCO.59L	Ø59MM
MCO.60L	Ø60MM
MCO.61L	Ø61MM
MCO.62L	Ø62MM
MCO.63L	Ø63MM

RAIL DRILLING - TCT ANNULAR CUTTER



Macstroc TCT annular cutters for Rail drilling, made of special carbide tips and superiorly designed to work in hardened rail and normal rail. Macstroc TCT rail cutters, provides maximum steadiness and power, and these cutters can drill the most high-tensile rail tracks. Macstroc also offers Solid twist drills (weldon shank) to work in rail tracks.

← 35MM →

CODE	DIA Ø
MRS.135	13.5
MRS.18	18
MRS.19	19
MRS.20	20
MRS.21	21
MRS.22	22
MRS.23	23
MRS.24	24
MRS.25	25
MRS.26	26
MRS.27	27
MRS.28	28
MRS.29	29
MRS.30	30
MRS.31	31
MRS.32	32
MRS.33	33
MRS.34	34
MRS.35	35
MRS.36	36

← 50MM →

CODE	DIA Ø
MRL.18	18
MRL.19	19
MRL.20	20
MRL.21	21
MRL.22	22
MRL.23	23
MRL.24	24
MRL.25	25
MRL.26	26
MRL.27	27
MRL.28	28
MRL.29	29
MRL.30	30
MRL.31	31
MRL.32	32
MRL.33	33
MRL.34	34
MRL.35	35
MRL.36	36
MRL.37	37

PILOT PIN

CODE	SIZE	ANNULAR CUTTERS
MRD.20	6.34 X 77	(Ø12-17) X25L
MRD.25	8 X 77	(Ø18-36) X25L
MRD.50	8 X 103	(Ø18-36) X50L

SOLID TWIST DRILL "WELDON SHANK"



← 25MM →



CODE	DIA Ø
MRT.6	6
MRT.8	8
MRT.9	9
MRT.10	10
MRT.11	11
MRT.12	12
MRT.135	13.5
MRT.16	16
MRT.17	17
MRT.18	18
MRT.19	19
MRT.20	20
MRT.22	22
MRT.27.5	27.5

SHEET METAL MINI-CUTTERS

SUITABLE FOR POWER DRILL 



CODE	SIZES
SMC.0625	Ø6MM- Ø25MM



Make burr-free holes quickly with Macstroc "sheet metal Mini Cutters", and this will provide you clean cut with pistol drill or press. Macstroc "sheet metal cutters" are made of high quality high speed steel for better endurance in metal sheets. Imperial sizes are also available upon request.

COUNTERSINK - WELDON SHANK



CODE	SIZES
COUNTER.25	25 X 90°
COUNTER.40	40 X 90°
COUNTER.50	50 X 90°

COUNTERSINK - STRAIGHT SHANK



CODE	SIZES
CON.06	Counter sink 6.3MM X 90°
CON.08	Counter sink 8.3MM X 90°
CON.10	Counter sink 10MM X 90°
CON.12	Counter sink 12.4MM X 90°
CON.16	Counter sink 16.5MM X 90°
CON.20	Counter sink 20.5MM X 90°
CON.25	Counter sink 25MM X 90°
CON.31	Counter sink 31MM X 90°
CON.40	Counter sink 40MM X 90°

STEP DRILLS



CODE	SIZES
SBT.12	12 MM (4/6/8/10/12)
SBT.20	20 MM (4/6/8/10/12/14/16/18/20)
SBT.30	30 MM (6/8/10/12/14/16/18/20/22/24/26/28/30)
SBT.38	38MM (6/9/13/16/19/21/23/26/29/32/35/38)

ACCESSORIES FOR MAGNETIC DRILLS

Extension adapters



CODE	SIZE	SHANK
MZXU50	50MM	WELDON
MZXU75	75MM	WELDON
MZXU100	100MM	WELDON



Morse taper Arbor - Weldon

CODE	SIZE	PRICE
MW-MT2	MT2	19.05
MW-MT3	MT3	19.05
MW-MT4	MT4	19.05
MW-MT5	MT5	19.05
MXW-MT3	MT3	31.75
MXW-MT4	MT4	31.75



Quick-in Arbor

CODE	SIZE	PRICE
QIN-MT2	MT2	19.05
QIN-MT3	MT3	19.05

Drill chucks & Adapters



CODE	SIZE
CHUK13-A	13MM / 1/2" x 20 UNF keyless chuck



CODE	SIZE
MZXU-01	Adapter For chuck 1/2" x 20 UNF - WELDON



CODE	SIZE
MZXU-B16	Twist drill Chuck adapter B16-connection



CODE	SIZE
MFX-03	Fein adapter (QUICKIN), for Weldon cutters



Auto coolant Arbor - WELDON

CODE	SIZE	PRICE
AMW-MT2	MT2	19.05
AMW-MT3	MT3	19.05
AMW-MT4	MT4	19.05

Tapper arbor for chuck



CODE	SIZE
ABR.2-B16	MT2- B16
ABR.3-B16	MT3- B16
ABR.2-B18	MT2- B18
ABR.3-B18	MT3- B18
ABR.3-B22	MT3- B22

External cooling device for Mag drills



CODE	DISCRIPTION
ECS.2A	External cooling device for Magnetic drills

TCT HOLESAW FOR STAINLESS STEEL

*AVAILABLE IN BIGGER DIAMETERS UPON REQUEST

RECOMMENDED CUTTING DEPTH 5 MM

RECOMMENDED CUTTING DEPTH 25 MM

◀10 MM ▶

◀30 MM ▶



CODE	DIA Ø
MSAW14	14MM
MSAW15	15MM
MSAW16	16MM
MSAW17	17MM
MSAW18	18MM
MSAW19	19MM
MSAW20	20MM
MSAW21	21MM
MSAW22	22MM
MSAW23	23MM
MSAW24	24MM
MSAW25	25MM
MSAW26	26MM
MSAW27	27MM
MSAW28	28MM
MSAW29	29MM
MSAW30	30MM
MSAW31	31MM
MSAW32	32MM
MSAW33	33MM
MSAW34	34MM
MSAW35	35MM
MSAW36	36MM
MSAW37	37MM
MSAW38	38MM
MSAW39	39MM
MSAW40	40MM
MSAW41	41MM
MSAW42	42MM

CODE	DIA Ø
MSAW43	43MM
MSAW44	44MM
MSAW45	45MM
MSAW46	46MM
MSAW47	47MM
MSAW48	48MM
MSAW49	49MM
MSAW50	50MM
MSAW51	51MM
MSAW55	55MM
MSAW56	56MM
MSAW57	57MM
MSAW58	58MM
MSAW60	60MM
MSAW63	63MM
MSAW65	65MM
MSAW70	70mm
MSAW71	71mm
MSAW73	73mm
MSAW74	74MM
MSAW75	75mm
MSAW76	76MM
MSAW77	77MM
MSAW78	78MM
MSAW80	80mm
MSAW85	85mm
MSAW90	90mm
MSAW95	95mm
MSAW100	100mm

CODE	DIA Ø
HSAW14	14MM
HSAW15	15MM
HSAW16	16MM
HSAW17	17MM
HSAW18	18MM
HSAW19	19MM
HSAW20	20MM
HSAW21	21MM
HSAW22	22MM
HSAW23	23MM
HSAW24	24MM
HSAW25	25MM
HSAW26	26MM
HSAW27	27MM
HSAW28	28MM
HSAW29	29MM
HSAW30	30MM
HSAW31	31MM
HSAW32	32MM
HSAW33	33MM
HSAW34	34MM
HSAW35	35MM
HSAW36	36MM
HSAW37	37MM
HSAW38	38MM
HSAW39	39MM
HSAW40	40MM
HSAW41	41MM
HSAW42	42MM

CODE	DIA Ø
HSAW43	43MM
HSAW44	44MM
HSAW45	45MM
HSAW46	46MM
HSAW47	47MM
HSAW48	48MM
HSAW49	49MM
HSAW50	50MM
HSAW51	51MM
HSAW55	55MM
HSAW56	56MM
HSAW57	57MM
HSAW58	58MM
HSAW60	60MM
HSAW63	63MM
HSAW65	65MM
HSAW70	70mm
HSAW71	71mm
HSAW73	73mm
HSAW75	75mm
HSAW76	76MM
HSAW78	78MM
HSAW80	80mm
HSAW85	85mm
HSAW88	88MM
HSAW90	90mm
HSAW95	95mm
HSAW100	100mm

CARBIDE BURRS—DOUBLE CUT

CYLINDRICAL SHAPE - SA



CODE	DIA ØMM	LENGH MM	SHANK ØMM	SHANK LENGTH
MA-0615	6	15	6	45
MA-0820	8	20	6	45
MA-1020	10	20	6	45
MA-1225	12.7	25	6	45
MA-1625	16	25	6	45
MA-2525	25	25	6	45

CYLINDRICAL SHAPE W/END CUT - SB



CODE	DIA ØMM	LENGH MM	SHANK ØMM	SHANK LENGTH
MB-0615	6	15	6	45
MB-0820	8	20	6	45
MB-1020	10	20	6	45
MB-1225	12.7	25	6	45
MB-1625	16	25	6	45
MB-2525	25	25	6	45

BALL NOSE CYLINDRICAL SHAPE -SC



CODE	DIA ØMM	LENGH MM	SHANK ØMM	SHANK LENGTH
MC-0615	6	15	6	45
MC-0820	8	20	6	45
MC-1020	10	20	6	45
MC-1225	12.7	25	6	45
MC-1625	16	25	6	45

SPHERICAL / BALL SHAPE - SD



CODE	DIA ØMM	LENGH MM	SHANK ØMM	SHANK LENGTH
MD-0656	6	5.7	6	45
MD-0872	8	7	6	45
MD-1008	10	8.5	6	45
MD-1210	12.7	10.5	6	45
MD-1614	16	14	6	45

OVAL SHAPE - SE



CODE	DIA ØMM	LENGH MM	SHANK ØMM	SHANK LENGTH
ME-0610	6	10	6	45
ME-0615	6	15	6	45
ME-0813	8	13	6	45
ME-1020	10	20	6	45
ME-1225	12.7	23/25	6	45
ME-1625	16	25	6	45

TREE SHAPE W/POINTED NOSE - SG



CODE	DIA ØMM	LENGH MM	SHANK ØMM	SHANK LENGTH
MG-0615	6	15	6	45
MG-0620	6	20	6	45
MG-0820	8	20	6	45
MG-1020	10	20	6	45
MG-1225	12.7	25	6	45
MG-1625	16	25	6	45

CARBIDE BURRS—DOUBLE CUT

TREE SHAPE WITH RADIUS END - SF

CODE	DIA ØMM	LENGH MM	SHANK ØMM	SHANK LENGTH
MF-0615	6	15	6	45
MF-1020	10	20	6	45
MF-1225	12.7	25	6	45
MF-1625	16	25	6	45

POINTED CONE SHAPE - SM

CODE	DIA ØMM	LENGH MM	SHANK ØMM	SHANK LENGTH
MM-0619	6	19	6	45
MM-0820	8	20	6	45
MM-1020	10	20	6	45
MM-1225	12.7	25	6	45

FLAME SHAPE -SH

CODE	DIA ØMM	LENGH MM	SHANK ØMM	SHANK LENGTH
MH-0615	6	15	6	45
MH-0820	8	20	6	45
MH-1020	10	20	6	45
MH-1225	12.7	25/30	6	45
MH-1625	16	25	6	45

BALL NOSE CONE - SL

CODE	DIA ØMM	LENGH MM	SHANK ØMM	SHANK LENGTH
ML-0620	6	20	6	45
ML-1020	10	20	6	45
ML-1025	10	25	6	45
ML-1220	12.7	20	6	45
ML-1225	12.7	25-30	6	45
ML-1625	16	25	6	45

CONE SHAPE 60° - SJ

CODE	DIA ØMM	LENGH MM	SHANK ØMM	SHANK LENGTH
MJ-0807	8	7	6	45
MJ-1087	10	8.7	6	45
MJ-1215	12	15	6	45
MJ-1614	16	14.8	6	45

CONE SHAPE 90° - SK

CODE	DIA ØMM	LENGH MM	SHANK ØMM	SHANK LENGTH
MK-0611	6	11	6	45
MK-0813	8	13	6	45

CODE	DESCRIPTION
MCB-5T	SET OF 5 PCS
MCB-10T	SET OF 10 PCS



OTHER PRODUCTS

SEAM LOCKER



CODE	MSL-1401
CAPACITY	0.8-1.25MM
VOLTAGE	110V OR 220V 50/60 HZ
SPEED	0-150RPM
WEIGHT	6KGS

LASER DISTANCE METER

CODE	DISTANCE IN METER	LASER COLOUR
ML-30	30	RED
ML-70	70	RED
ML-100	100	RED
MGL-70	70	GREEN



MULTI-PURPOSE BITS FOR GLASS & TILE



CODE	DIAØ MM	LENGTH – MM
GT030	3	80
GT040	4	80
GT050	5	80
GT060	6	100
GT070	7	110
GT080	8	110
GT100	10	120
GT120	12	120
GT140	14	120
GT160	16	120



SET

CODE	DIAØ MM/ SET	PCS
GTK-4-A	Glass & Tile Drill Bit set of 4MM, 6MM, 8MM, 10MM	4
GTK5-A	Glass & Tile Drill Bit set of 3MM, 4MM, 6MM, 8MM, 10MM	5
GTK5-B	Glass & Tile Drill Bit set of 4MM, 6MM, 8MM, 10MM and 12MM	5
GTK7-A	Glass & Tile Drill Bit set of 3MM, 4MM, 5MM, 6MM, 8MM, 10MM and 12MM	7
GTK-3A	Glass & Tile Drill Bit set of 6MM, 8MM, 10MM	3

WARRANTY

MACSTROC WARRANTY



WHAT IS COVERED

All Macstroc electric machines come with a standard 12 months manufacturer's warranty in accordance with the following provisions:

Macstroc issues the warranty by undoing malfunctions free of charge that clearly presented themselves in the warranty period and which follow from faulty material or a manufacturing error. The standard warranty period is 12 months, commencing upon the first user's acquisition. The decisive factor is the purchasing date stated on the original proof of purchase. Macstroc shall undo the malfunction by repairing or replacing the failing machine, or parts thereof, at its discretion, without charging labour costs or costs for parts. Macstroc may replace malfunctioning machinery or parts thereof by new or reconditioned machinery or parts thereof. All machinery and parts replaced become property of Macstroc.

HOW YOU CAN GET SERVICE

The warranty claim must be lodged within the warranty period. This requires the submission or sending of the complete tool in question with the original sales receipt, which must indicate the purchase date and the product designation, must be submitted to the Macstroc distributor in your country. The distributor Service Center should be notified in writing of any additional accessories installed in the machine.

NORMAL WEAR AND TEAR

The Warranty does not cover consumables or parts of limited regular functionality due to their natural wear and tear. The Warranty does not cover for Mechanical or electric damages resulting from incorrect installation, operator's misuse or other activities inconsistent with the operation manual or contradictory to technical specifications attached to the machine.

USE GENUINE PARTS !

Use only accessories that are recommended by Macstroc for your model. Warranty does not cover if you are using any additional accessories on machines without prior approval of authorised Macstroc distributors.

MACSTROC®

MACSTROC PVT LTD,
11300060, 128 CITY ROAD,
LONDON, EC1V 2NX, UK

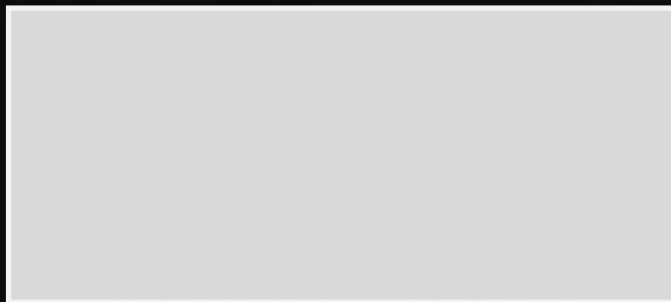

AUTHORIZED DISTRIBUTOR



WWW.MACSTROC.CO.UK

INFO@MACSTROC.COM